

PCB-Magazine Series: 601 - 603 (alt)  
Series: 601.1-603.1  
Series: 601.2-603.2

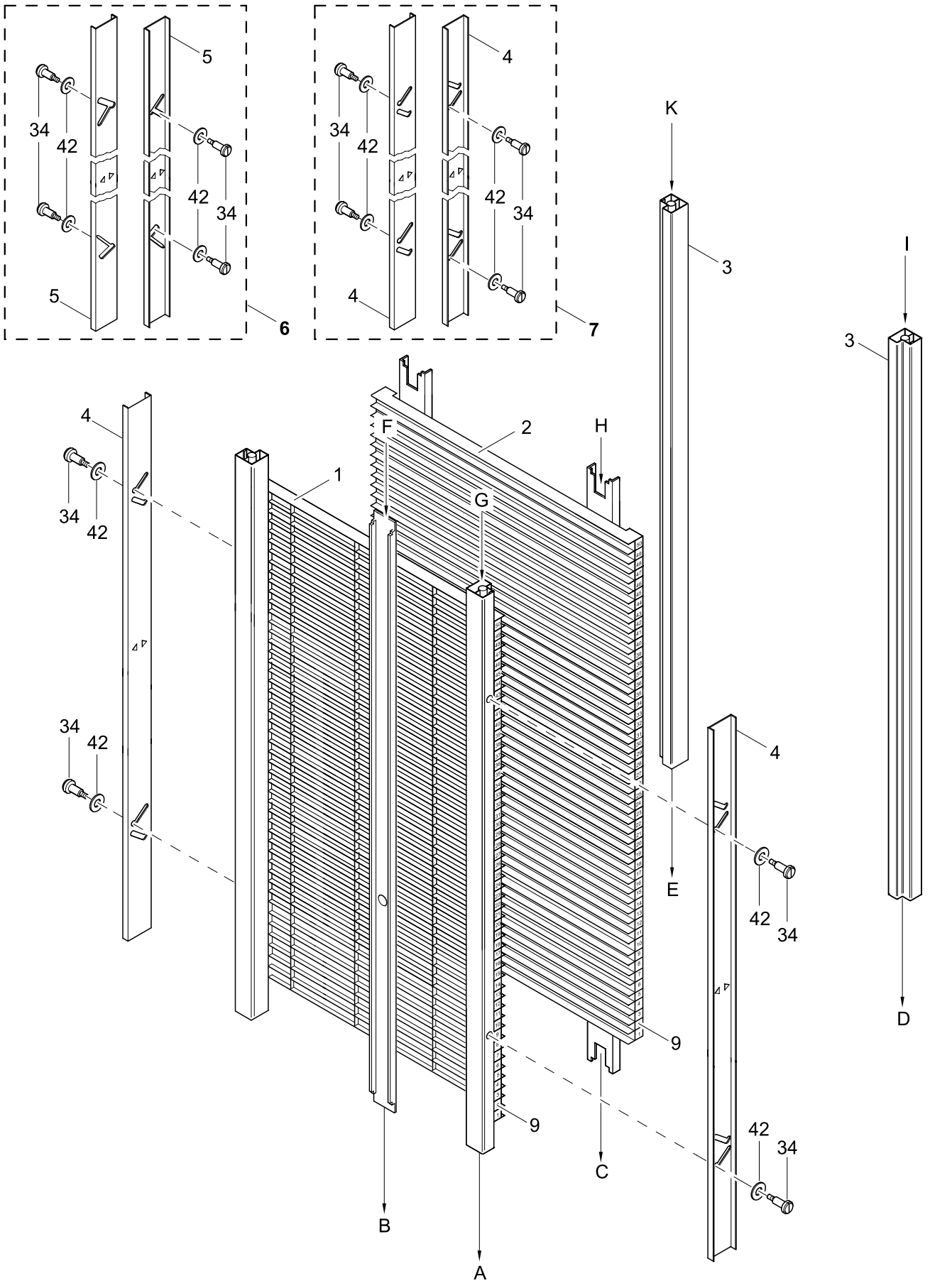

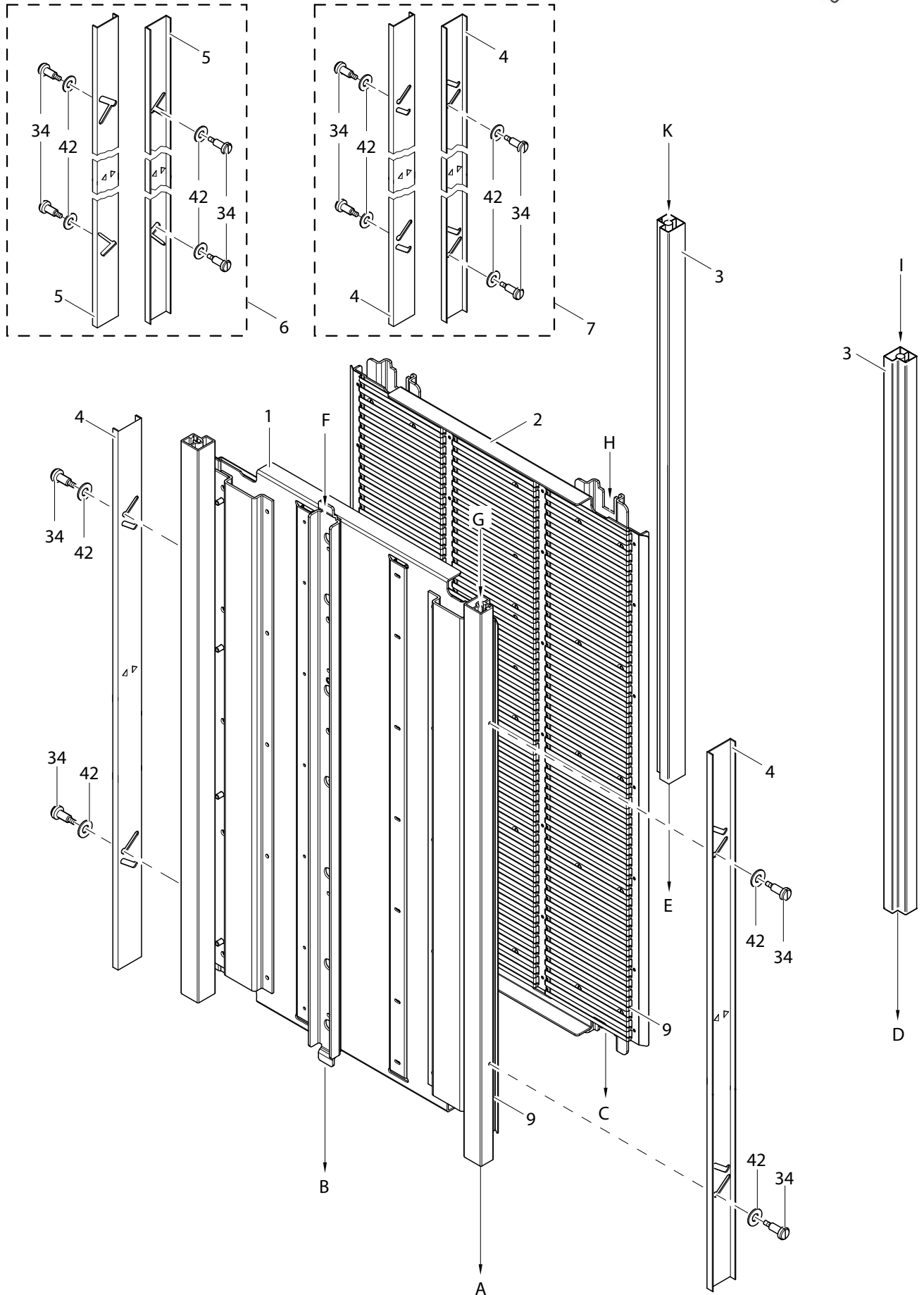

PCB-Magazine Series: 601 - 603 (alt)  
Series: 601.1-603.1  
Series: 601.2-603.2  
Series: 603.3-603.3

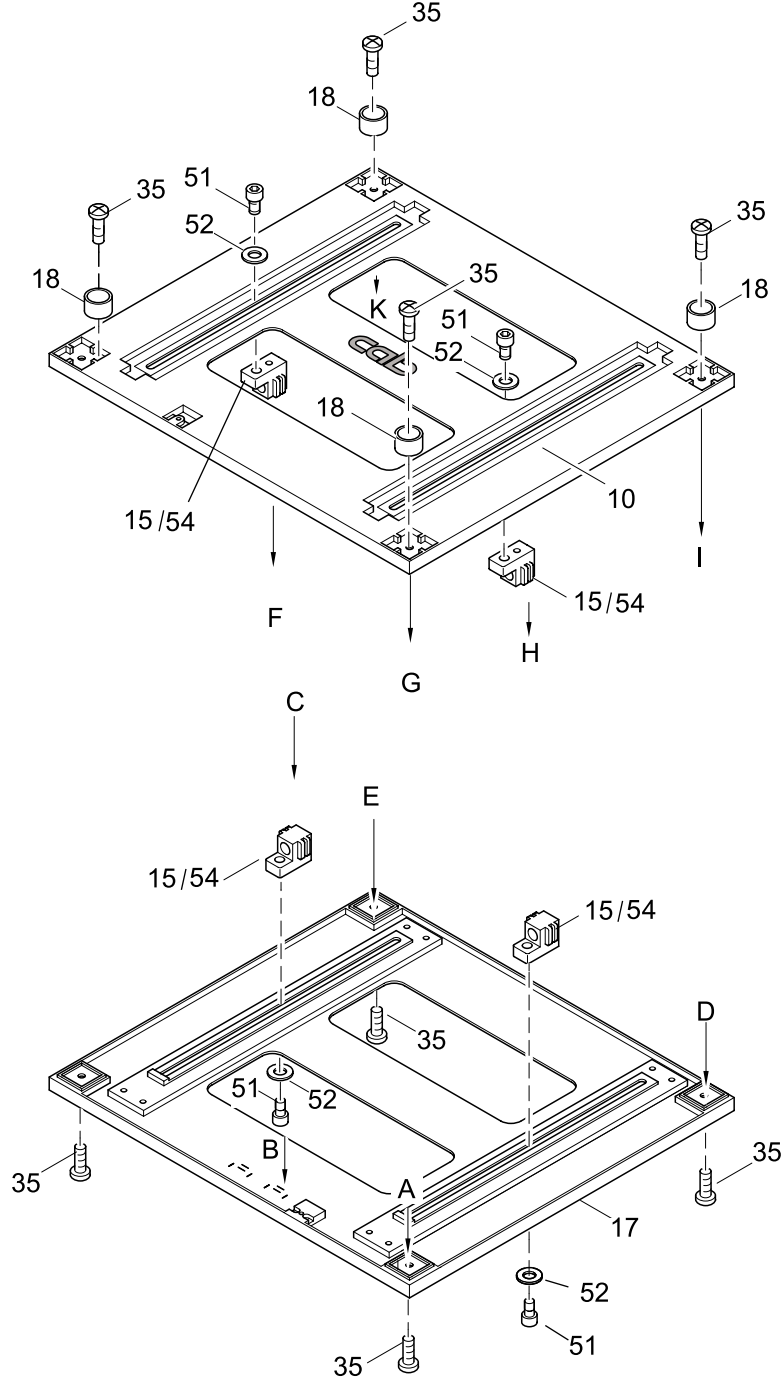

Pos.	Description	Part.-No.			
		Typ 603 (alt) 8913133	Typ 603.1 8917603	Typ 603.2 8916603	Typ 603.3 8915603
1	Rack wall fixed, complete	8915607.001	8915607.001	8915403.001	8915141.001
2	Rack wall moveable, complete	8915608.001	8915608.001	8915404.001	8915136.001
3	Profile	8913065.001	8913065.001	8913065.001	8913065.001
4	Standard safety bar	8913119.001	8913119.001	8913119.001	8913119.001
5	Turning safety bar	8913014.001	8913014.001	8913014.001	8913014.001
6	Transport safety 2	8913152.001	8913152.001	8913152.001	8913152.001
7	Transport safety 1	8913151.001	8913151.001	8913151.001	8913151.001
8					
9	Positioning strip	8913115.001	8913115.001	8913115.001	8913115.001
10	Ground plate, complete	8913905.001	8913905.001	8913905.001	8915369.001
11					
12					
13					
14					
15	Rack wall holder	8915286.001	8915286.001	8915286.001	8915393.001
16					
17	Ground plate, complete	8913905.001	8913905.001	8913905.001	8915369.001
18	Stackable plate	8913438.001	8913438.001	8913438.001	8913438.001
19					
20					
21					
22					
23					
24					
25					
26					
27					
28					
29					
30					
31					
32					
33					
34	Screw DIN923-M3x 2	5902339.001	5902339.001	5902339.001	5902339.001
35	Screw DIN7985-M 5x16	5902350.001	5902350.001	5902350.001	5902350.001
36					
37					
38					
39					
40					
41					
42	Washer DIN988- 4x8x1,0	5903089.001	5903089.001	5903089.001	5903089.001
43					
44					
45					
46					
47					
48					
49	Mounting instruction	9008259.001	9008259.001	9008259.001	9008259.001
50					
51	Screw DIN912-M5x16	5902038.001	5902038.001	5902038.001	5902038.001
52	Washer DIN9021-5,3	5903037.001	5903037.001	5903037.001	5903037.001
53	Nut DIN 562-M5	5902549.001	5902549.001	5902549.001	5902549.001
54	Sliding foil	—	—	—	8913965.001
55					