

PCB-Magazine Series: 701 - 703 (alt), 704 (alt), 801 - 809 (alt)

Series: 701.1 - 704.1

Series: 701.2 - 703.2

Series: 704.2 - 719.2

Series: 801.1 - 804.1

Series: 804.2 - 809.2

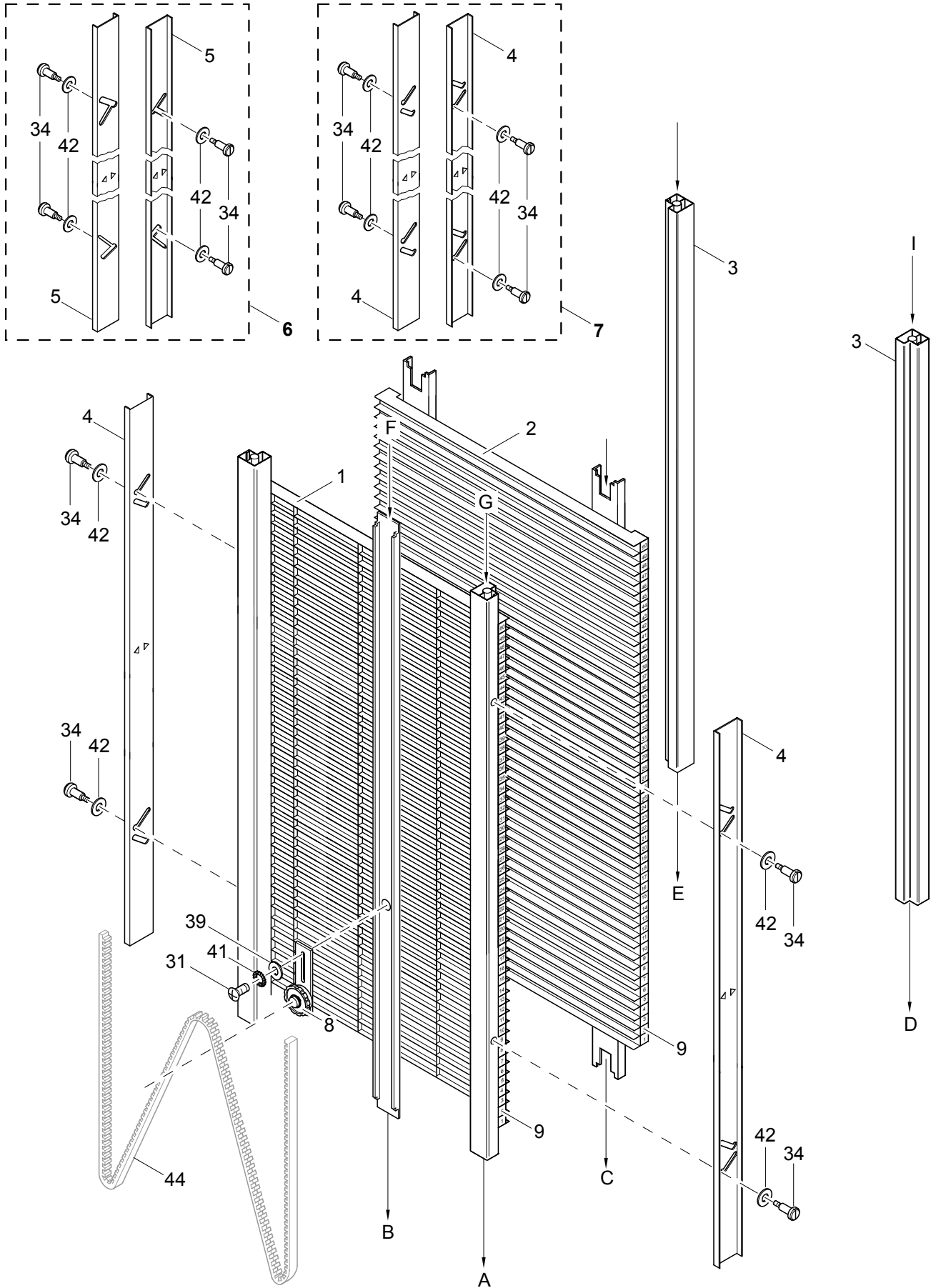

PCB-Magazine Series: 801 - 803 (alt)  
Series: 801.1-803.1  
Series: 801.2-803.2  
Series: 801.3-803.3

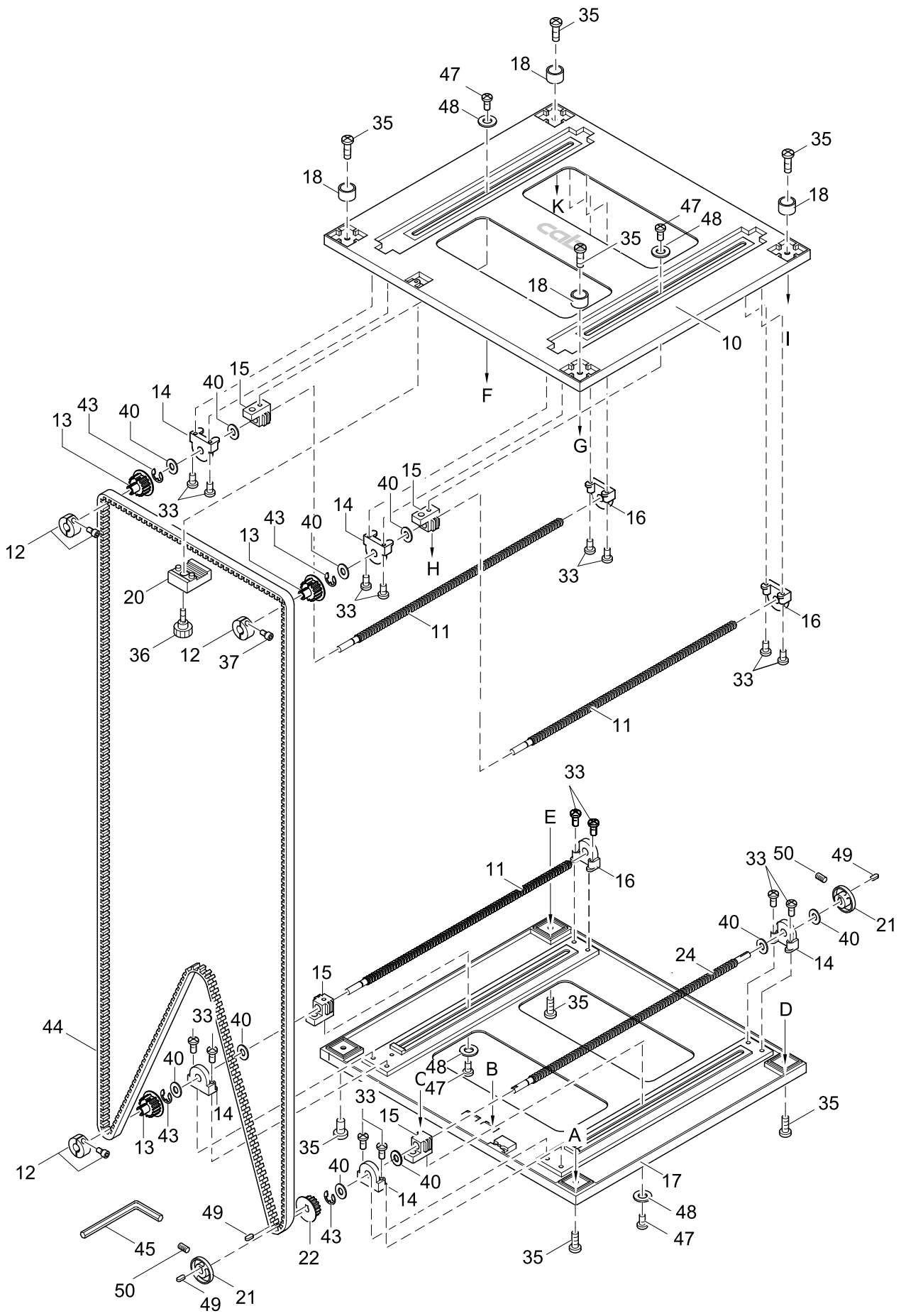

Pos.	Description	Part.-No.			
		Typ 802 (Guss alt)	Typ 802.1 8917802	Typ 802.2 8916802	Typ 802.3 8915802
1	Rack wall fixed, complete	8915607.001	8915607.001	8915403.001	8915141.001
2	Rack wall moveable, complete	8915608.001	8915608.001	8915404.001	8915136.001
3	Profile	8913065.001	8913065.001	8913065.001	8913065.001
4	Standard safety bar	8913119.001	8913119.001	8913119.001	8913119.001
5	Turning safety bar	8913014.001	8913014.001	8913014.001	8913014.001
6	Transport safety 2	8913152.001	8913152.001	8913152.001	8913152.001
7	Transport safety 1	8913151.001	8913151.001	8913151.001	8913151.001
8	Guide roller, complete	8913179.001	8913179.001	8913179.001	8913179.001
9	Positioning strip	8913115.001	8913115.001	8913115.001	8913115.001
10	Top plate, complete	8913882.001	8913882.001	8913882.001	8913882.001
11	Spindle	8913101.001	8913101.001	8913101.001	8913101.001
12	Clamp hoop	8913220.001	8913220.001	8913220.001	8913220.001
13	Belt pulley	8913019.001	8913019.001	8913019.001	8913019.001
14	Bearing block, complete	8913505.001	8913505.001	8913505.001	8913505.001
15	Nut / Rack wall holder	8915286.001	8915286.001	8915286.001	8915286.001
16	Bearing block	8913437.001	8913437.001	8913437.001	8913437.001
17	Ground plate, complete	8913884.001	8913884.001	8913884.001	8913884.001
18	Stackable plate	8913438.001	8913438.001	8913438.001	8913438.001
19	Bottom plate	8913025.001	8913025.001	8913025.001	8913025.001
20	Clamping plate	8913107.001	8913107.001	8913107.001	8913107.001
21	Clutch disc	8913427.001	8913427.001	8913427.001	8913427.001
22	Drive belt pulley	8913243.001	8913243.001	8913243.001	8913243.001
23					
24	Drive screw	8913244.001	8913244.001	8913244.001	8913244.001
25					
26					
27					
28					
29					
30					
31	Screw DIN7985-M 4x10-4.8	5902022.001	5902022.001	5902022.001	5902022.001
32					
33	Screw DIN7985-M 4x16-4.8	5902091.001	5902091.001	5902091.001	5902091.001
34	Screw DIN923-M3x 2	5902339.001	5902339.001	5902339.001	5902339.001
35	Screw DIN7985-M 5x16	5902350.001	5902350.001	5902350.001	5902350.001
36	Screw M4x12 rot	5902351.001	5902351.001	5902351.001	5902351.001
37					
38					
39	Washer DIN9021-4,3	5903005.001	5903005.001	5903005.001	5903005.001
	Washer DIN988- 6x12x0,3	5903008.001	5903008.001	5903008.001	5903008.001
40	Washer DIN988- 6x10x1,0	5903079.001	5903079.001	5903079.001	5903079.001
	Washer DIN988- 6x10x0,5	5903105.001	5903105.001	5903105.001	5903105.001
41	Toothed Washer DIN6797-A4.3	5903011.001	5903011.001	5903011.001	5903011.001
42	Washer DIN988- 4x8x1,0	5903089.001	5903089.001	5903089.001	5903089.001
43	E-Ring DIN6799-5	5903505.001	5903505.001	5903505.001	5903505.001
44	Gear belt 672XL 025	5905556.001	5905556.001	5905556.001	5905556.001
45	Screw-wrench DIN911-2,5mm	5909031.001	5909031.001	5909031.001	5909031.001
46	Mounting instruction	9008260.001	9008260.001	9008260.001	9008260.001
47	Screw KB40x10	5902227.001	5902227.001	5902227.001	5902227.001
48	Washer DIN9021-4,3	5903005.001	5903005.001	5903005.001	5903005.001
49	Parallel Key DIN6885-A2x2x8	5905569.001	5905569.001	5905569.001	5905569.001
50	Set Screw DIN916-M3x4	5904509.001	5904509.001	5904509.001	5904509.001
51					
52					
53					
54					
55					