

- Postes de travail
- Etablis
- Plateaux
- Coffres à tiroirs
- Armoires à tiroirs
- Armoires
- Dessertes
- Accessoires
- Sièges d'atelier
- Sur-mesure



CATALOGUE PRODUITS  
2024

CONCEPTION SUR MESURE



Conception  
Fabrication  
Française

■ Implantation.....	1
■ Nuanciers.....	2
■ Postes de travail.....	3
■ Etablis.....	9
■ Plateaux.....	12
■ Coffres à tiroirs.....	15
■ Armoires à tiroirs.....	19
■ Armoires.....	21
■ Dessertes.....	23
■ Accessoires.....	26
■ Sièges d'atelier.....	42
■ Sur-mesure.....	51

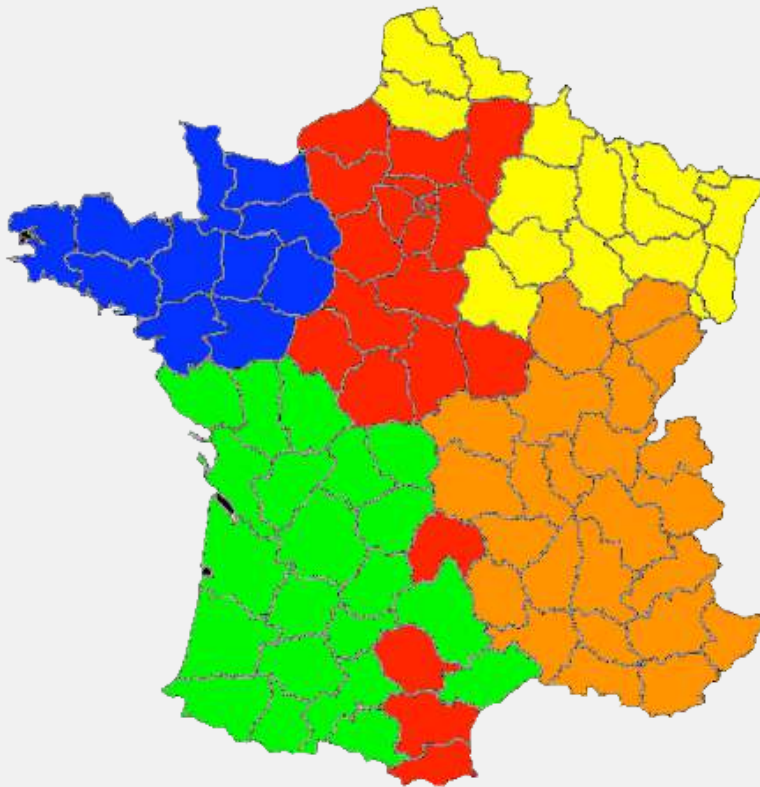

- Gilles Moreau:  
[gmoreau@davumtmc.com](mailto:gmoreau@davumtmc.com)  
06 07 81 22 20
- Thomas Carpentier:  
[tcarpentier@davumtmc.com](mailto:tcarpentier@davumtmc.com)  
06 70 62 57 87
- Benjamin Henry:  
[bhenry@davumtmc.com](mailto:bhenry@davumtmc.com)  
06 80 59 40 28
- Steve Ewald :  
[sewald@davumtmc.com](mailto:sewald@davumtmc.com)  
06 07 06 40 09
- Michel Gallard:  
[mgallard@davumtmc.com](mailto:mgallard@davumtmc.com)  
06 88 15 35 70

Fondée en 1981 en tant que filiale d'Usinor-Sacilor, notre société possède une expérience de plus de 30 ans dans la distribution industrielle.

Notre offre produit est principalement axée sur la fourniture d'équipement industriel et de consommables spécifiques pour répondre aux besoins actuels des industries. Nous avons mis en place un réel support technique pour la mise en œuvre des équipements, dans les secteurs clés où notre entreprise est présente : Electronique, Aéronautique, Autosport, Maroquinerie, Logistique.

Certifiée ISO 9001 depuis 1999 notre objectif est d'apporter le meilleur service à nos clients. Nos investissements récents en matériel (ERP), la formation que nous assurons à notre personnel, notre logistique, nous permettent de fiabiliser nos processus internes, ceci pour améliorer notre efficacité.

Une approche personnalisée pour chacun de nos clients nous permet de mieux comprendre vos besoins, tout en vous offrant un large choix de produits.

Notre expérience dans la fabrication, combinée à la plus grande motivation de nos équipes, nous permettent d'envisager un réel partenariat, pour sécuriser vos approvisionnements avec des produits de grande qualité.

En choisissant DAVUM-TMC, nous prenons l'engagement de vous apporter un service d'excellence que votre Entreprise est en droit d'attendre, car votre exigence fait partie de nos préoccupations quotidiennes.

---

**Peintures**

RAL 9002

RAL 7035  
ESD

RAL 5005

RAL 7021  
ESD

---

**Plateaux**

CAOUTCHOUC  
NOIR

MÉLAMINÉ  
GRIS CLAIR

INOX

MDF

STRATIFIÉ  
GRIS DAUPHIN  
ESD

STRATIFIÉ  
GRIS DAUPHIN

# ▲ DAV 100

- Piétement de poste de travail en tube d'acier de 35 x 35 mm
- Réglable en hauteur manuellement de 700 à 950 mm
- Réglage par profilé en C de 30 x 30 mm
- Bouchon au sol anti cisaillement
- Roulettes à oeil adaptable Ø 75/125 mm
- Profilé avant & cadre arrière pouvant accueillir coffres et superstructures
- Charge admissible: 300 kg
- Disponible en largeur: 1100/1500/1800/2000mm
- Disponible en profondeur: 620/800/1000 mm



Largeur x Profondeur	Références
1100 x 620 mm	DAV100-1100-620
1500 x 620 mm	DAV100-1500-620
1800 x 620 mm	DAV100-1800-620
2000 x 620 mm	DAV100-2000-620
1100 x 800 mm	DAV100-1100-800
1500 x 800 mm	DAV100-1500-800
1800 x 800 mm	DAV100-1800-800
2000 x 800 mm	DAV100-2000-800
1100 x 1000 mm	DAV100-1100-1000
1500 x 1000 mm	DAV100-1500-1000
1800 x 1000 mm	DAV100-1800-1000
2000 x 1000 mm	DAV100-2000-1000
Autres dimensions : nous consulter	

# ▲ DAV 200

- Piétement de poste de travail en tube rectangulaire d'acier de 80 x 40 et 90 x 40 mm
- Réglable en hauteur manuellement de 680 à 1030 mm au pas de 25 mm par indexeur
- Vérins de mise à niveau
- Roulettes à oeil adaptable Ø 75/125 mm
- Profilé avant & cadre arrière pouvant accueillir coffres et superstructures
- Charge admissible: 500 kg
- Disponible en largeur: 1100/1500/1850/2000mm
- Disponible en profondeur: 620/800 mm



Largeur x Profondeur	Références
1100 x 620 mm	DAV200-1100-620
1500 x 620 mm	DAV200-1500-620
1800 x 620 mm	DAV200-1800-620
2000 x 620 mm	DAV200-2000-620
1100 x 800 mm	DAV200-1100-800
1500 x 800 mm	DAV200-1500-800
1800 x 800 mm	DAV200-1800-800
2000 x 800 mm	DAV200-2000-800

Autres dimensions : nous consulter

# ▲ DAV300

- Structure de poste de travail électrique en tôle d'acier plié de 89 x 57 mm
- Réglable en hauteur électrique course : 795 à 1295 mm
- 4 colonnes télescopiques simple extension Course 500 mm
- Vitesse de réglage de 18 à 38 mm / seconde
- Vérins de mise à niveau
- Roulettes à oeil adaptable Ø 75/125 mm
- Profilé avant & cadre arrière pouvant accueillir coffres et superstructures
- Systeme anti-collision
- Charge admissible: 500 kg
- Disponible en largeur: 1100/1500/1850/2000mm
- Disponible en profondeur: 620/800/1000 mm



Largeur x Profondeur	Références
1100 x 620 mm	DAV300-1100-620
1500 x 620 mm	DAV300-1500-620
1800 x 620 mm	DAV300-1800-620
2000 x 620 mm	DAV300-2000-620
1100 x 800 mm	DAV300-1100-800
1500 x 800 mm	DAV300-1500-800
1800 x 800 mm	DAV300-1800-800
2000 x 800 mm	DAV300-2000-800
1100 x 1000 mm	DAV300-1100-1000
1500 x 1000 mm	DAV300-1500-1000
1800 x 1000 mm	DAV300-1800-1000
2000 x 1000 mm	DAV300-2000-1000
Autres dimensions : nous consulter	

# ▲ DAV 400

- Structure de poste de travail électrique à 2 colonnes double extension de section 80 x 50 mm
- Réglable en hauteur électrique course : 655 à 1280 mm
- Vitesse de réglage de 18 à 38 mm / seconde
- Vérins de mise à niveau
- Roulettes à oeil adaptable Ø 75/125 mm
- Profilé avant & cadre arrière pouvant accueillir coffres et superstructures
- Système anti-collision
- Charge admissible: 250 kg
- Disponible en largeur: 1100/1500/1850/2000mm
- Disponible en profondeur: 620/800 mm



Largeur x Profondeur	Références
1100 x 620 mm	DAV400-1100-620
1500 x 620 mm	DAV400-1500-620
1800 x 620 mm	DAV400-1800-620
2000 x 620 mm	DAV400-2000-620
1100 x 800 mm	DAV400-1100-800
1500 x 800 mm	DAV400-1500-800
1800 x 800 mm	DAV400-1800-800
2000 x 800 mm	DAV400-2000-800
Autres dimensions : nous consulter	



# ▲ DAV500

- Structure de poste de travail électrique à 2 colonnes simple extension de section 80 x 60 mm
- Réglable en hauteur électrique course : 500 à 1180 mm
- Vitesse de réglage de 18 à 33 mm / seconde
- Vérins de mise à niveau
- Roulettes à oeil adaptable Ø 75/125 mm
- Superstructure fixée sur le plan de travail
- Système anti-collision
- Charge admissible: 240 kg
- Disponible en largeur: 850 à 2000 mm
- Disponible en profondeur: 620/700/800 mm



<b>Largeur x Profondeur</b>	<b>Références</b>
850-2000 x 620-800 mm	DAV500
Autres dimensions : nous consulter	

# DAV 600

- Structure de poste de travail électrique à 2 colonnes aluminium simple extension de section 196 x 148 mm Course 500 mm
- Hauteur : 740 - 1240 mm
- Vitesse de réglage jusqu'à 20 mm / seconde
- Vérins de mise à niveau
- Roulettes à platine adaptable Ø 100 mm
- Profilé avant & cadre arrière pouvant accueillir coffres et superstructures
- Système anti-collision
- Charge admissible: 500 kg
- Disponible en largeur: 1100/1500/1850/2000 mm
- Disponible en profondeur: 620/800 mm
- Profondeur 1000 mm sur 4 colonnes - 1000Kg Sur demande



Largeur x Profondeur	Références
1100 x 620 mm	DAV600-1100-620
1500 x 620 mm	DAV600-1500-620
1800 x 620 mm	DAV600-1800-620
2000 x 620 mm	DAV600-2000-620
1100 x 800 mm	DAV600-1100-800
1500 x 800 mm	DAV600-1500-800
1800 x 800 mm	DAV600-1800-800
2000 x 800 mm	DAV600-2000-800
Autres dimensions : nous consulter	

# ▲ DAV700

- Structure d'établi fixe en tôle d'acier
- Pied plié de section 85 x 55 mm
- Hauteur fixe de 800 mm
- Profondeur 665 / 865 mm
- Platine au sol anti cisaillement
- Vérins de mise à niveau adaptable
- Spittage au sol possible
- Perçage de la platine Ø 11 mm
- Roulettes à oeil adaptable Ø 75/125 mm
- Profilé avant & cadre arrière pouvant accueillir coffres et superstructures
- Charge admissible: 500 kg
- Disponible en largeur: 1100/1300/1500/1800/2000/2400 mm
- Disponible en profondeur: 800/1000 mm



Largeur x Profondeur	Références
1100 x 800 mm	DAV700-1100-800
1300 x 800 mm	DAV700-1300-800
1500 x 800 mm	DAV700-1500-800
1800 x 800 mm	DAV700-1800-800
2000 x 800 mm	DAV700-2000-800
2400 x 800 mm	DAV700-2400-800
1100 x 1000 mm	DAV700-1100-1000
1300 x 1000 mm	DAV700-1300-1000
1500 x 1000 mm	DAV700-1500-1000
1800 x 1000 mm	DAV700-1800-1000
2000 x 1000 mm	DAV700-2000-1000
2400 x 1000 mm	DAV700-2400-1000
Autres dimensions : nous consulter	

# DAV 800

- Structure d'établi réglable en hauteur manuellement
- Pied plié de section 85 x 55 mm
- Réglable en hauteur 700 à 970 mm sous plateau
- Profondeur 665 / 865 mm
- Platine 80 x 53 mm au sol anti cisaillement
- Vérins de mise à niveau adaptable
- Spittage au sol possible
- Perçage de la platine Ø 11 mm
- Roulettes à oeil adaptable Ø 75/125 mm
- Profilé avant & cadre arrière pouvant accueillir coffres et superstructures
- Charge admissible: 500 kg
- Disponible en largeur: 1100/1300/1500/1800/2000/2400 mm
- Disponible en profondeur: 800/1000 mm



Largeur x Profondeur	Références
1100 x 800 mm	DAV800-1100-800
1300 x 800 mm	DAV800-1300-800
1500 x 800 mm	DAV800-1500-800
1800 x 800 mm	DAV800-1800-800
2000 x 800 mm	DAV800-2000-800
2400 x 800 mm	DAV800-2400-800
1100 x 1000 mm	DAV800-1100-1000
1300 x 1000 mm	DAV800-1300-1000
1500 x 1000 mm	DAV800-1500-1000
1800 x 1000 mm	DAV800-1800-1000
2000 x 1000 mm	DAV800-2000-1000
2400 x 1000 mm	DAV800-2400-1000
Autres dimensions : nous consulter	



## DAV900

- Structure d'établi fixe en tôle d'acier
- Pied plié de section 100 x 70 mm
- Hauteur fixe de 800 mm
- Profondeur 665 mm
- Platine au sol anti cisaillement
- Vérins de mise à niveau adaptable
- Spittage au sol possible
- Perçage de la platine Ø 11 mm
- Roulettes à oeil adaptable Ø 75/125 mm
- Profilé avant & cadre arrière pouvant accueillir coffres et superstructures
- Charge admissible : 1000 kg
- Disponible en largeur: 1100/1300/1500/1800/2000/2400 mm
- Disponible en profondeur: 800 mm

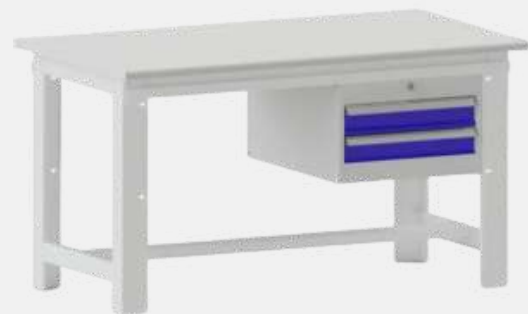

Largeur x Profondeur	Références
1100 x 800 mm	DAV900-1100-800
1300 x 800 mm	DAV900-1300-800
1500 x 800 mm	DAV900-1500-800
1800 x 800 mm	DAV900-1800-800
2000 x 800 mm	DAV900-2000-800
2400 x 800 mm	DAV900-2400-800
1100 x 1000 mm	DAV900-1100-1000
1300 x 1000 mm	DAV900-1300-1000
1500 x 1000 mm	DAV900-1500-1000
1800 x 1000 mm	DAV900-1800-1000
2000 x 1000 mm	DAV900-2000-1000
2400 x 1000 mm	DAV900-2400-1000
Autres dimensions : nous consulter	

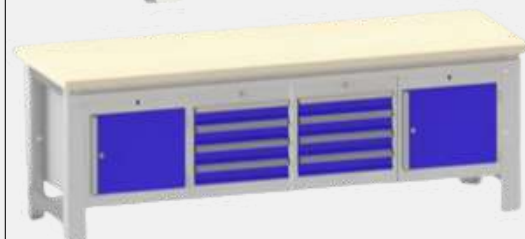

# PLATEAUX

## MÉLAMINÉ

- Panneau de particules comprimées en haute densité recouvert sur les deux faces d'un papier décor imprimé gris clair équivalent RAL 7047
- Épaisseur 30 mm
- 4 chants plaqués en ABS 2 mm gris RAL 7047

P(mm)	Ép(mm)	L 1100	L 1300	L 1500	L 1800	L 2000	L 2400
620	30	PLAT-MELA-1100-620-30	PLAT-MELA-1300-620-30	PLAT-MELA-1500-620-30	PLAT-MELA-1800-620-30	PLAT-MELA-2000-620-30	PLAT-MELA-2400-620-30
800	30	PLAT-MELA-1100-800-30	PLAT-MELA-1300-800-30	PLAT-MELA-1500-800-30	PLAT-MELA-1800-800-30	PLAT-MELA-2000-800-30	PLAT-MELA-2400-800-30



## STRATIFIÉ

- Panneau de particules comprimées en haute densité
- Feuille de stratifié Gris Dauphin 6/10e - RAL 7047
- Plateau postformé une longueur 1/2 de rond, en agglo 28 mm Contrebalancement blanc 8/10e, 3 chants plaqués ABS 2 mm Épaisseur 29 mm
- Plateau 4 chants droits en agglo 38 mm - Contrebalancement blanc 8/10e, 4 chants plaqués ABS 2 mm Épaisseur 39 mm

P(mm)	Ép(mm)	L 1100	L 1300	L 1500	L 1800	L 2000	L 2400
620	29	PLAT-ST-1100-620-29	PLAT-ST-1300-620-29	PLAT-ST-1500-620-29	PLAT-ST-1800-620-29	PLAT-ST-2000-620-29	PLAT-ST-2400-620-29
800	29	PLAT-ST-1100-800-29	PLAT-ST-1300-800-29	PLAT-ST-1500-800-29	PLAT-ST-1800-800-29	PLAT-ST-2000-800-29	PLAT-ST-2400-800-29
1000	29	PLAT-ST-1100-1000-29	PLAT-ST-1300-1000-29	PLAT-ST-1500-1000-29	PLAT-ST-1800-1000-29	PLAT-ST-2000-1000-29	PLAT-ST-2400-1000-29
620	39	PLAT-ST-1100-620-39	PLAT-ST-1300-620-39	PLAT-ST-1500-620-39	PLAT-ST-1800-620-39	PLAT-ST-2000-620-39	PLAT-ST-2400-620-39
800	39	PLAT-ST-1100-800-39	PLAT-ST-1300-800-39	PLAT-ST-1500-800-39	PLAT-ST-1800-800-39	PLAT-ST-2000-800-39	PLAT-ST-2400-800-39
1000	39	PLAT-ST-1100-1000-39	PLAT-ST-1300-1000-39	PLAT-ST-1500-1000-39	PLAT-ST-1800-1000-39	PLAT-ST-2000-1000-39	PLAT-ST-2400-1000-39



## TABLETTE MÉLAMINÉE

- Tablette basse en mélaminé pour DAV 700 & DAV 800
- 4 chants droits plaqués ABS 2 mm - Épaisseur 19 mm

P(mm)	Ép(mm)	L 1100	L 1300	L 1500	L 1800	L 2000	L 2400
550	19	TAB-MELA-1100-550-19	TAB-MELA-1300-550-19	TAB-MELA-1500-550-19	TAB-MELA-1800-550-19	TAB-MELA-2000-550-19	TAB-MELA-2400-550-19
750	19	TAB-MELA-1100-750-19	TAB-MELA-1300-750-19	TAB-MELA-1500-750-19	TAB-MELA-1800-750-19	TAB-MELA-2000-750-19	TAB-MELA-2400-750-19





## STRATIFIÉ ESD

- Panneau de particules comprimées en haute densité
- Feuille de stratifié Gris 8/10e - RAL 7047
- Une sous-couche de carbone assure la conductivité
- Résistance superficielle avec mise à la terre :  $1 \times 10^4$  à  $10^5$  Ohms
- Résistivité superficielle:  $1 \times 10^5$  à  $9 \times 10^6$  Ohms
- Résistivité transversale :  $1 \times 10^5$  à  $9 \times 10^6$
- Conforme à la norme NF EN 61340-5-1
- Connection de dissipation électrostatique située sur le plan de travail à relier à la terre pour évacuer l'électricité statique
- Plateau postformé une longueur 1/2 de rond, en agglo 28 mm  
Contrebalancement blanc 8/10e, 3 chants plaqués ABS 2 mm  
Épaisseur 29 mm
- Plateau 4 chants droits en agglo 38 mm - Contrebalancement blanc 8/10e, 4 chants plaqués ABS 2 mm  
Épaisseur 39 mm



P(mm)	Ép(mm)	L 1100	L 1300	L 1500	L 1800	L 2000	L 2400
620	29	PLAT-STESD-1100-620-29	PLAT-STESD-1300-620-29	PLAT-STESD-1500-620-29	PLAT-STESD-1800-620-29	PLAT-STESD-2000-620-29	PLAT-STESD-2400-620-29
800	29	PLAT-STESD-1100-800-29	PLAT-STESD-1300-800-29	PLAT-STESD-1500-800-29	PLAT-STESD-1800-800-29	PLAT-STESD-2000-800-29	PLAT-STESD-2400-800-29
1000	29	PLAT-STESD-1100-1000-29	PLAT-STESD-1300-1000-29	PLAT-STESD-1500-1000-29	PLAT-STESD-1800-1000-29	PLAT-STESD-2000-1000-29	PLAT-STESD-2400-1000-29
620	39	PLAT-STESD-1100-620-39	PLAT-STESD-1300-620-39	PLAT-STESD-1500-620-39	PLAT-STESD-1800-620-39	PLAT-STESD-2000-620-39	PLAT-STESD-2400-620-39
800	39	PLAT-STESD-1100-800-39	PLAT-STESD-1300-800-39	PLAT-STESD-1500-800-39	PLAT-STESD-1800-800-39	PLAT-STESD-2000-800-39	PLAT-STESD-2400-800-39
1000	39	PLAT-STESD-1100-1000-39	PLAT-STESD-1300-1000-39	PLAT-STESD-1500-1000-39	PLAT-STESD-1800-1000-39	PLAT-STESD-2000-1000-39	PLAT-STESD-2400-1000-39



## KIT ESD

- Bornier universel ESD de mise à la terre cordon 3 mètres
- Fiche de connexion UE - 2 x m5
- Vis bois alu 10mm pour liaison ESD
- Cordon de terre 3m p10 femelle
- Ensemble fixation pression 10mm
- Bracelet ESD tissu bleu réglable Pression 4mm
- Cordon torsadé ESD pression 4mm Fiche banane femelle
- Cordon mise à la terre ESD

# PLATEAUX

## CAOUTCHOUC



- Panneau de particules comprimées en haute densité
- Plateau 4 chants droits en agglo 38 mm - Contrebalancement blanc8/10e, 4 chants plaqués ABS 2 mm- Gris
- Néoprène lisse noir de 3 mm collé
- Épaisseur 41 mm

P(mm)	Ép(mm)	L 1100	L 1300	L 1500	L 1800	L 2000	L 2400
620	41	PLAT-CATC-1100-620-41	PLAT-CATC-1300-620-41	PLAT-CATC-1500-620-41	PLAT-CATC-1800-620-41	PLAT-CATC-2000-620-41	PLAT-CATC-2400-620-41
800	41	PLAT-CATC-1100-800-41	PLAT-CATC-1300-800-41	PLAT-CATC-1500-800-41	PLAT-CATC-1800-800-41	PLAT-CATC-2000-800-41	PLAT-CATC-2400-800-41
1000	41	PLAT-CATC-1100-1000-41	PLAT-CATC-1300-1000-41	PLAT-CATC-1500-1000-41	PLAT-CATC-1800-1000-41	PLAT-CATC-2000-1000-41	PLAT-CATC-2400-1000-41

## INOX



- Panneau de particules comprimées en haute densité (MDF) Épaisseur 38 mm
- Recouvert d'un plateau inox 304L - Épaisseur 2 mm
- Plateau 4 chants droits - Angles soudés
- Épaisseur total 40 mm

P(mm)	Ép(mm)	L 1100	L 1300	L 1500	L 1800	L 2000	L 2400
620	40	PLAT-IX-1100-620-40	PLAT-IX-1300-620-40	PLAT-IX-1500-620-41	PLAT-IX-1800-620-40	PLAT-IX-2000-620-40	PLAT-IX-2400-620-40
800	40	PLAT-IX-1100-800-40	PLAT-IX-1300-800-40	PLAT-IX-1500-800-40	PLAT-IX-1800-800-40	PLAT-IX-2000-800-40	PLAT-IX-2400-800-40
1000	40	PLAT-IX-1100-1000-40	PLAT-IX-1300-1000-40	PLAT-IX-1500-1000-40	PLAT-IX-1800-1000-40	PLAT-IX-2000-1000-40	PLAT-IX-2400-1000-40

## MDF



- Panneau constitué de matériaux composites en fibres de bois et d'un liant synthétique - Médium
- Densité : 800 kg M3 +/- 25 Kg
- Épaisseur 38 mm
- 4 chants droits ABS 2 mm - Gris plaqués

P(mm)	Ép(mm)	L 1100	L 1300	L 1500	L 1800	L 2000	L 2400
620	38	PLAT-MDF-1100-620-38	PLAT-MDF-1300-620-38	PLAT-MDF-1500-620-38	PLAT-MDF-1800-620-38	PLAT-MDF-2000-620-38	PLAT-MDF-2400-620-38
800	38	PLAT-MDF-1100-800-38	PLAT-MDF-1300-800-38	PLAT-MDF-1500-800-38	PLAT-MDF-1800-800-38	PLAT-MDF-2000-800-38	PLAT-MDF-2400-800-38
1000	38	PLAT-MDF-1100-1000-38	PLAT-MDF-1300-1000-38	PLAT-MDF-1500-1000-38	PLAT-MDF-1800-1000-38	PLAT-MDF-2000-1000-38	PLAT-MDF-2400-1000-38



# ▲ COFFRES À TIROIRS

## Série 700

- Coffre à tiroirs en tôle d'acier ép 10/10e
- Glissières simples Ouverture 90%
- Système anti basculement
- Verrouillage centralisé avec clés  
Livré avec deux clés
- Charge admissible par tiroir: 100 kg
- Chariot sur roulettes adaptables -  
Hauteur socle 135 mm



DAV-135-1-11

300

300



DAV-135-1-12

75  
100  
125  
300

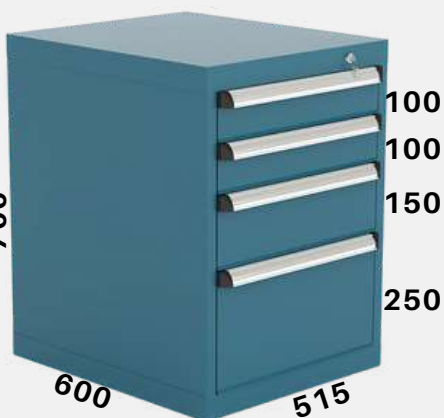

DAV-135-1-15

100  
100  
150  
250



DAV-135-1-17

75  
100  
100  
125  
200

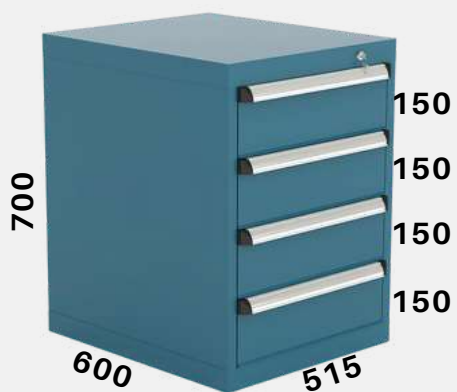

DAV-135-1-13

150  
150  
150  
150

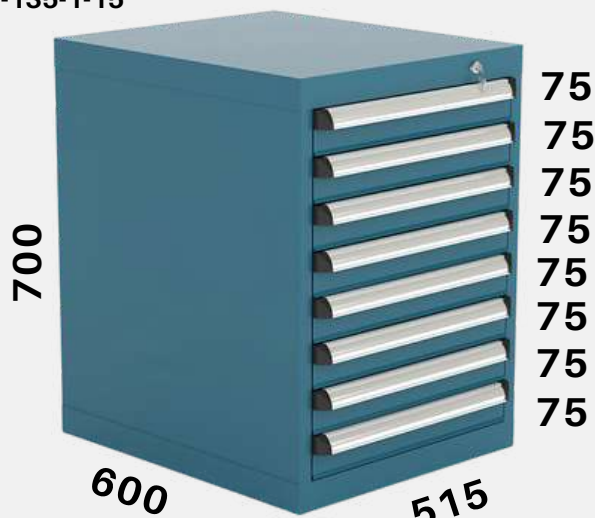

DAV-135-1-19

75  
75  
75  
75  
75  
75  
75  
75



DAV-135-1-14

75  
75  
200  
250



DAV-135-1-16

75  
75  
100  
150  
200

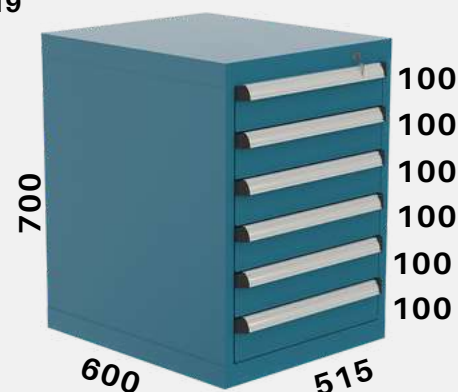

DAV-135-1-18

100  
100  
100  
100  
100  
100

# ▲ COFFRES À TIROIRS

## Série 830

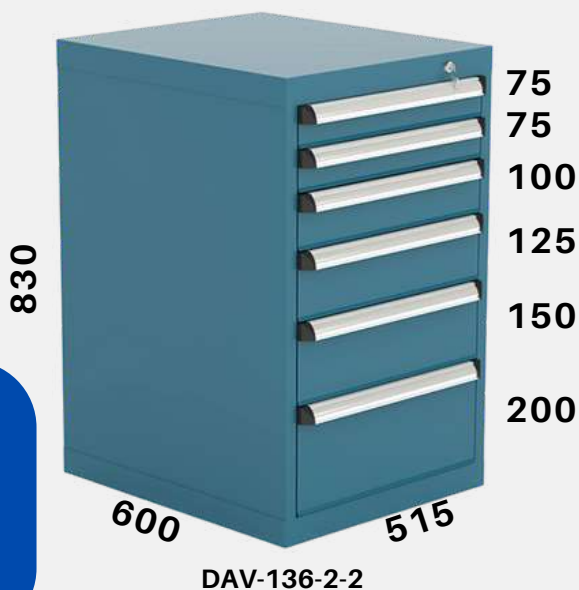

- Coffre à tiroirs en tôle d'acier ép 10/10e
- Glissières simples Ouverture 90%
- Système anti basculement
- Verrouillage centralisé avec clés Livré avec deux clés
- Charge admissible par tiroir: 100 kg
- Réalisation d'établi pied-coffre avec structure DAV 700 / 800
- Chariot sur roulettes adaptables - Hauteur socle 135 mm

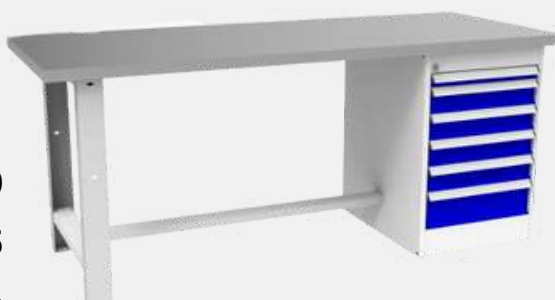
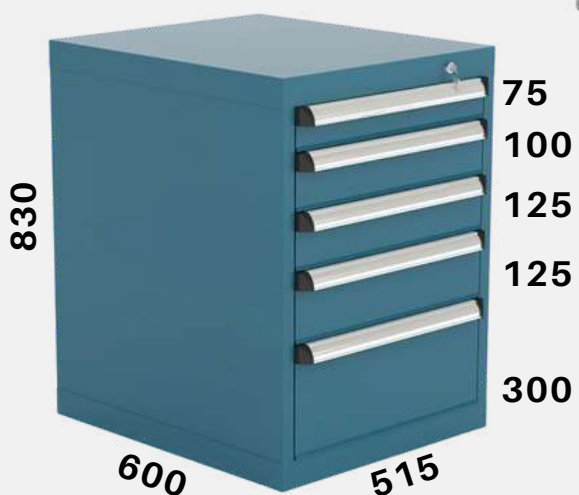

DAV-135-515

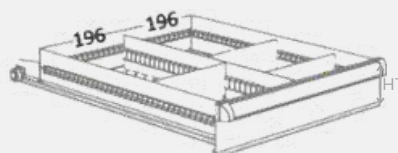

DAV-135-HT-D1

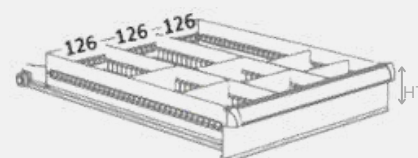

DAV-135-HT-D2

### Aménagement de tiroirs métallique

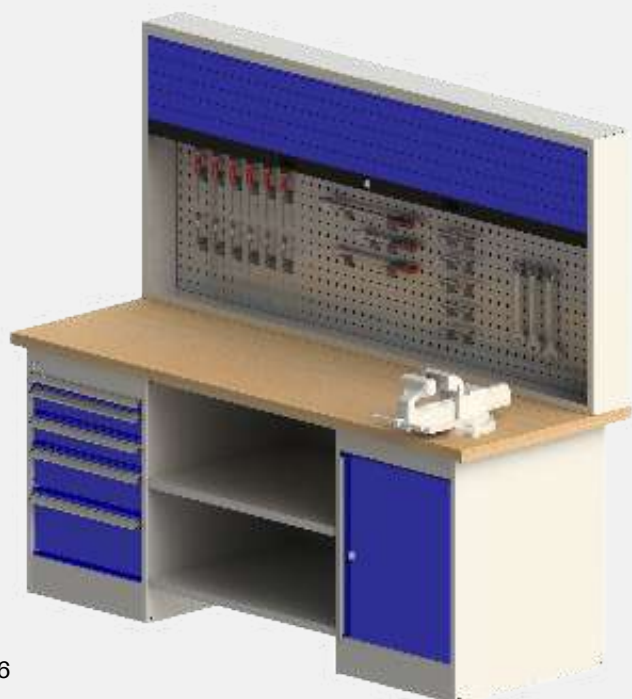

DAV-135-75-D1	DAV-135-75-D2
DAV-135-100-D1	DAV-135-100-D2
DAV-135-125-D1	DAV-135-125-D2
DAV-135-150-D1	DAV-135-150-D2
DAV-135-200-D1	DAV-135-200-D2
DAV-135-300-D1	DAV-135-300-D2

# ▲ COFFRES À TIROIRS

## Série 360

- Coffre à tiroirs en tôle d'acier ép 8/10e
- Glissières simples Ouverture 100%
- Charge admissible par tiroir: 15 kg
- Coffre suspendu pour structure  
DAV100/200/300/400/500/600/700/800/900
- Chariot sur roulettes adaptables - Hauteur socle 135 mm



## Profils fixation Coffre

Profondeur 620 mm : PFC-620  
Profondeur 800 mm : PFC-800  
Profondeur 1000 mm : PFC-1000



DAV-106-4-1

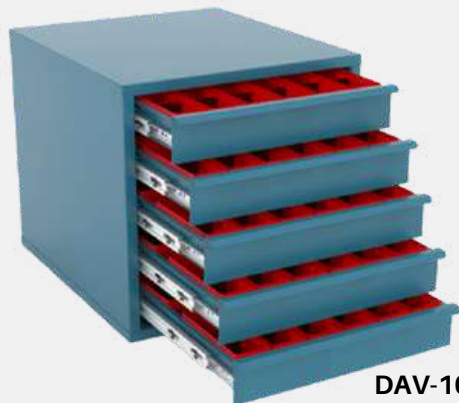
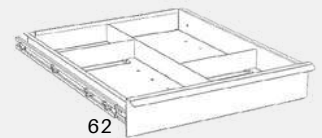
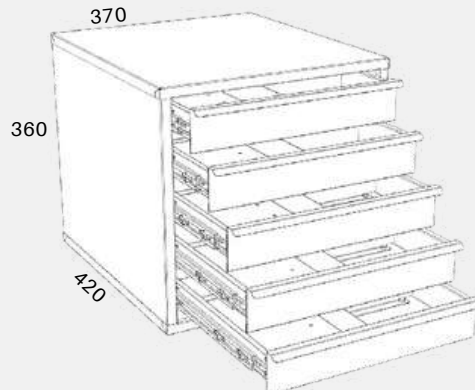

DAV-106-4-2

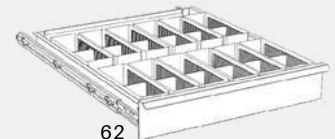
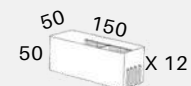
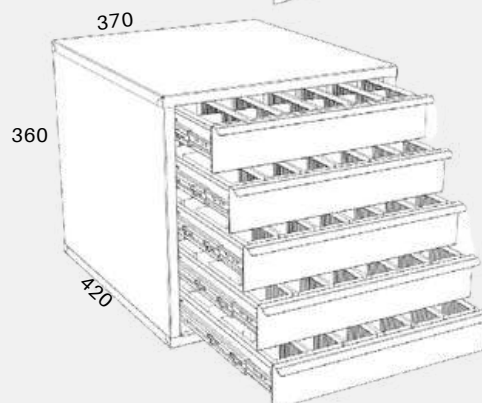

DAV-106-4-3

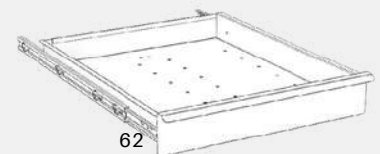
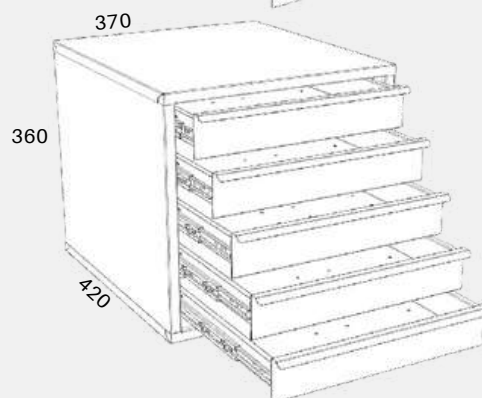

DAV-106-4-4

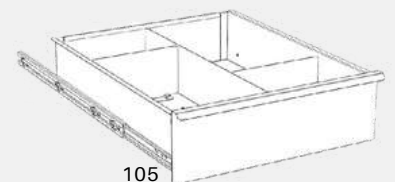
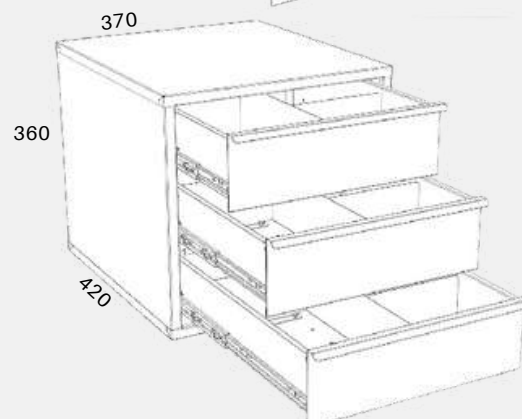

# ▲ COFFRES À TIROIRS

## Série 200 - 300 - 400 - 500

- Coffre à tiroirs en tôle d'acier ép 10/10e
- Glissières simples Ouverture 100%
- Charge admissible par tiroir: 100 kg
- Coffre suspendu pour structure  
DAV100/200/300/400/500/600/700/800/900
- Chariot sur roulettes adaptables - Hauteur socle 135 mm
- Aménagement de tiroirs amovibles intégré

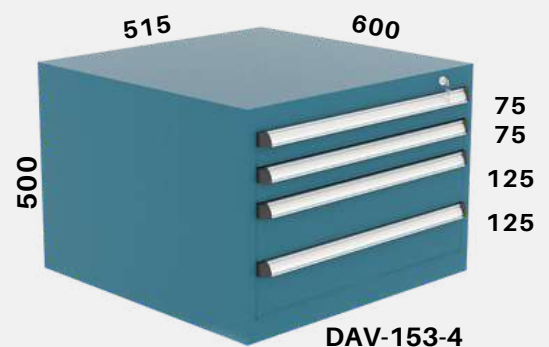
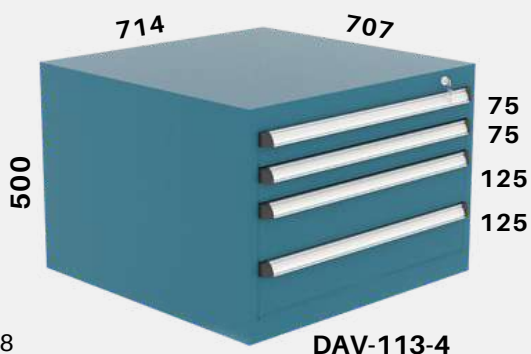
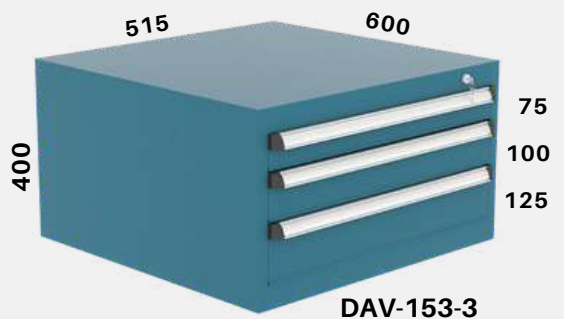
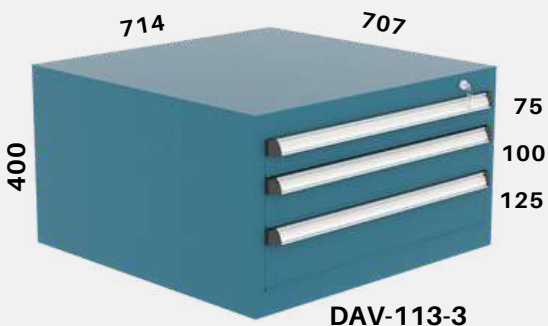
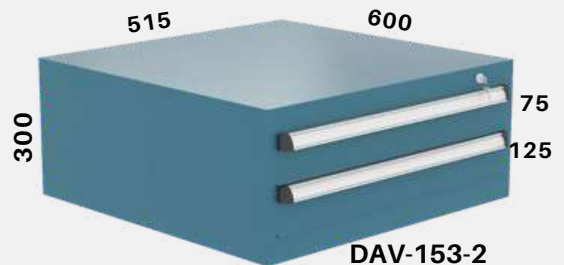
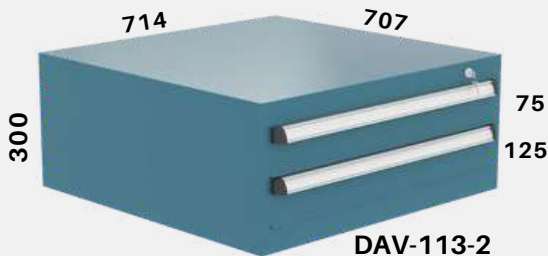
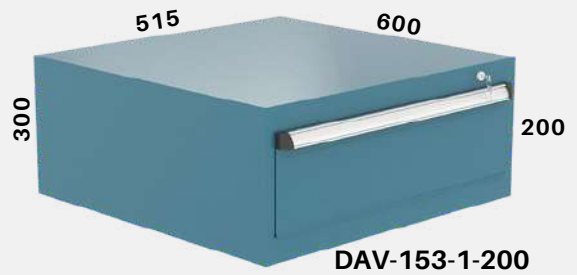
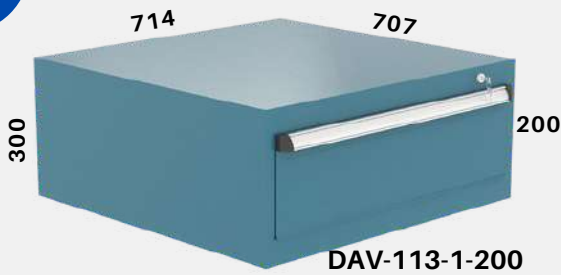
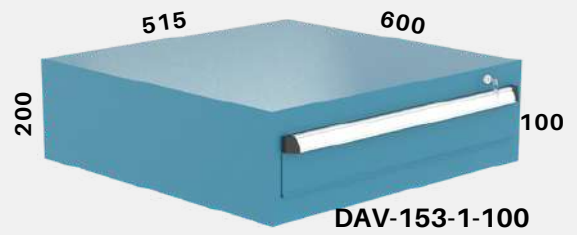
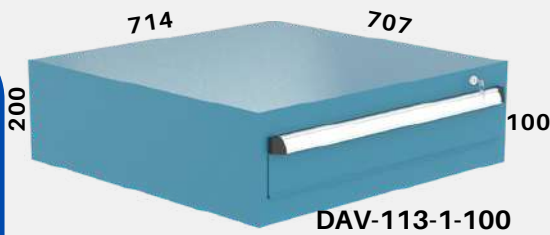

# ARMOIRES À TIROIRS

## Série 700

- Coffre à tiroirs en tôle d'acier ép 10/10e
- Glissières simple Ouverture 90%
- Charge admissible par tiroir: 100 kg
- Dimension tiroir : 602 x 490 mm
- Chariot sur roulettes adaptables - Hauteur socle 135 mm



DAV-135-714

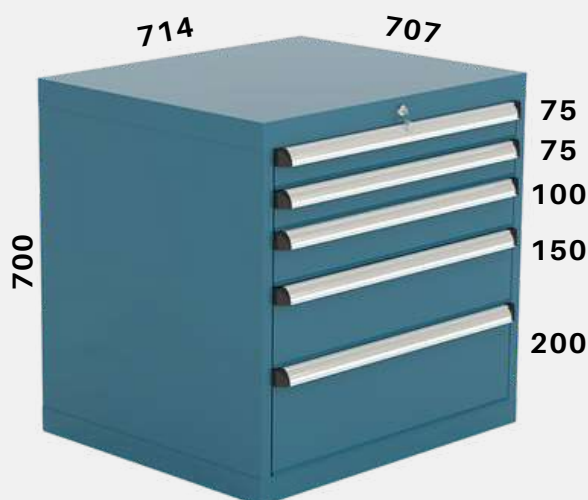

DAV-122-1-16

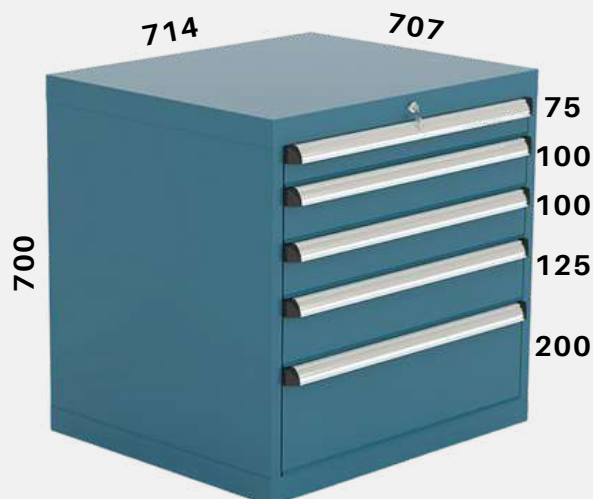

DAV-122-1-17

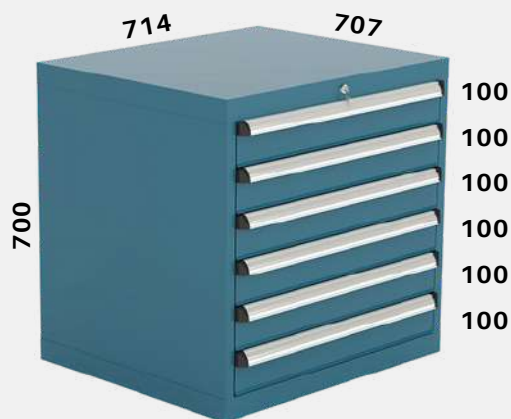

DAV-122-1-18

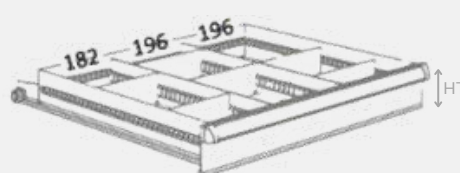

DAV-122-HT-D1

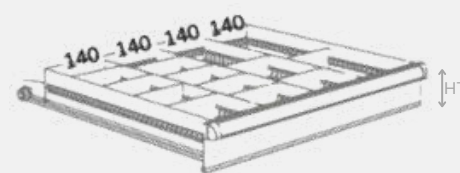

DAV-122-HT-D2

Aménagement de tiroirs métallique

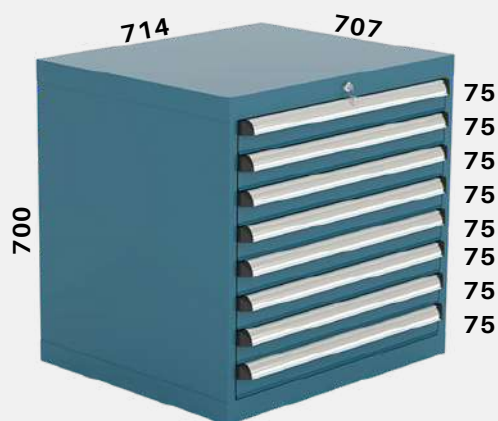

DAV-122-1-19

DAV-122-75-D1	DAV-122-75-D2
DAV-122-100-D1	DAV-122-100-D2
DAV-122-125-D1	DAV-122-125-D2
DAV-122-150-D1	DAV-122-150-D2
DAV-122-200-D1	DAV-122-200-D2

## ARMOIRES À TIROIRS

### Série 1000

- Coffre à tiroirs en tôle d'acier ép 10/10e
- Glissières simple Ouverture 90%
- Charge admissible par tiroir: 100 kg
- Dimensions tiroir : 910 x 602 mm

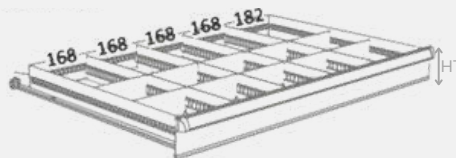

DAV-119-HT-D3

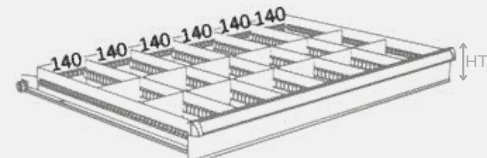

DAV-119-HT-D4

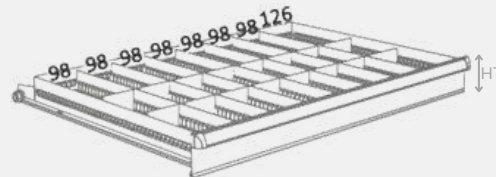

DAV-119-HT-D6

Aménagement de tiroirs métallique

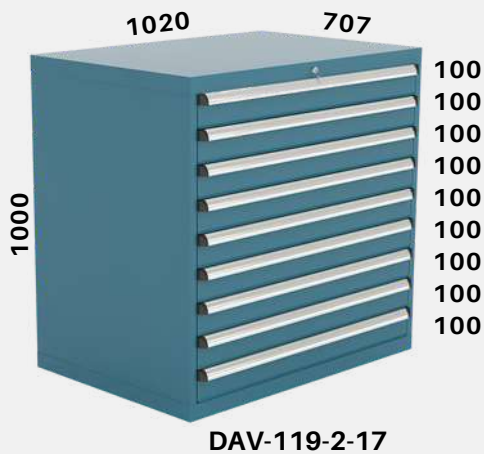

DAV-119-2-17

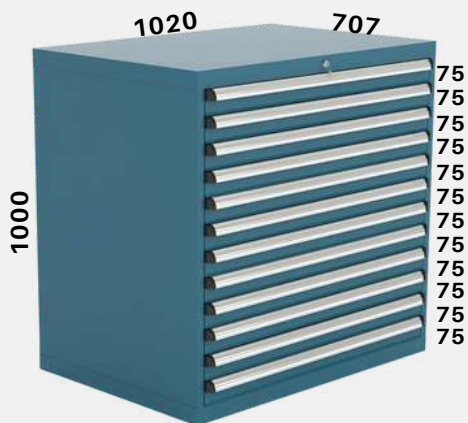

DAV-119-2-19

DAV-119-75-D3	DAV-119-75-D4	DAV-119-75-D6
DAV-119-100-D3	DAV-119-100-D4	DAV-119-100-D6
DAV-119-125-D3	DAV-119-125-D4	DAV-119-125-D6
DAV-119-150-D3	DAV-119-150-D4	DAV-119-150-D6
DAV-119-200-D3	DAV-119-200-D4	DAV-119-200-D4
DAV-119-250-D3	DAV-119-250-D4	DAV-119-250-D6

# ARMOIRES

## Armoire haute portes battantes

- Armoire monobloc en tôle d'acier ép 10/10e
- 3 profondeurs 460, 540 ou 660 mm
- Portes battantes fermeture 3 points à clé
- Equipée de 5 tablettes réglables au pas de 50 mm
- Charge 200 kg par tablette

H (mm)	L (mm)	P (mm)	Références
2000	1005	460	ARM-HT-PP-460
2000	1005	540	ARM-HT-PP-540
2000	1005	660	ARM-HT-PP-660



## Armoire haute portes transparentes

- Armoire monobloc en tôle d'acier ép 10/10e
- 3 profondeurs 460, 540 ou 660 mm
- Portes battantes transparentes en polycarbonate fermeture 3 points à clé
- Equipée de 5 tablettes réglables au pas de 50 mm
- Charge 200 kg par tablette

H (mm)	L (mm)	P (mm)	Références
2000	1000	460	ARM-HT-PV-460
2000	1000	540	ARM-HT-PV-540
2000	1000	660	ARM-HT-PV-660



## Armoire basse portes battantes

- Armoire monobloc en tôle d'acier ép 10/10e
- 3 profondeurs 460, 540 ou 660 mm
- Portes battantes fermeture 3 points à clé
- Equipée de 2 tablettes réglables
- Charge 200 kg par tablette



H (mm)	L (mm)	P (mm)	Références
1000	1005	460	ARM-B-PP-460
1000	1005	540	ARM-B-PP-590
1000	1005	660	ARM-B-PP-660



## Armoire basse portes transparentes

- Armoire monobloc en tôle d'acier ép 10/10e
- 3 profondeurs 460, 540 ou 660 mm
- Portes battantes transparentes en polycarbonate fermeture 3 points à clé
- Equipée de 2 tablettes réglables
- Charge 200 kg par tablette



H (mm)	L (mm)	P (mm)	Références
1000	1005	460	ARM-B-PV-460
1000	1005	540	ARM-B-PV-590
1000	1005	660	ARM-B-PV-660





## Desserte d'atelier

- Construction en tube carré 30x30 mm équipée d'une tablette basse avec 4 rebords 650 x 500 mm
- Equipée de 4 roulettes Ø 75 mm pivotantes dont 2 avec freins
- Dimensions Hauteur 800 x largeur 640 x Prof. 750 mm
- Charge admissible : 100 kg



Stratifié ep 29 mm	P750mm	L640mm	DESS-ATL-ST29
Stratifié ep 38 mm	P750mm	L640mm	DESS-ATL-ST38

## Desserte réglable

- Desserte réglable en hauteur de 730 à 1020 mm à l'aide de deux poignées débrayables
- Equipée d'un plateau stratifié ou stratifié ESD de 800 x 500 x 29 mm
- Tablette basse de 420 x 790 mm permettant le positionnement d'un bac Europe 600x400 mm
- Equipée d'une poignée de manutention
- 4 roulettes Ø 75 mm dont 2 à freins et 2 sans freins
- Charge admissible : 50 kg



Stratifié ep 29 mm	P500mm	L800mm	DESS-R-ST29
Stratifié ESD ep 29 mm	P500mm	L800mm	DESS-R-STESD29

## Desserte montants centrés hauteur 1650 mm

- 2 Montants en " T " hauteur 1500 mm perforés
- 1 Tablette basse avec rebords
- 4 Roulettes Ø 125 mm pivotantes dont 2 avec freins
- 1 poignée de manutention
- 2 profondeurs 450 ou 613 mm
- Reçoit en option tablettes et accessoires

H (mm)	L (mm)	P (mm)	Références
1650	695	450	DESS-MC-1650-695-450
1650	925	450	DESS-MC-1650-925-450
1650	1300	450	DESS-MC-1650-1300-450
1650	695	613	DESS-MC-1650-695-613
1650	925	613	DESS-MC-1650-925-613
1650	1300	613	DESS-MC-1650-1300-613



## Desserte montants centrés hauteur 1250 mm

- 2 Montants en " T " hauteur 850 mm perforés
- 1 Tablette basse avec rebords
- 4 Roulettes Ø 125 mm pivotantes dont 2 avec freins
- 1 poignée de manutention
- 2 profondeurs 450 ou 613 mm
- Reçoit en option tablettes et accessoires

H (mm)	L (mm)	P (mm)	Références
1250	695	450	DESS-MC-1250-695-450
1250	925	450	DESS-MC-1250-925-450
1250	1300	450	DESS-MC-1250-1300-450
1250	695	613	DESS-MC-1250-695-613
1250	925	613	DESS-MC-1250-925-613
1250	1300	613	DESS-MC-1250-1300-613



## Desserte montants décentrés hauteur 1650 mm

- 2 Montants en " L " hauteur 1500 mm perforés
- 1 Tablette basse avec rebords L 870 x P 450 ou 613 mm
- 4 Roulettes Ø 125 mm pivotantes dont 2 avec freins
- 1 poignée de manutention
- Reçoit en option tablettes et accessoires



H (mm)	L (mm)	P (mm)	Références
1650	695	450	DESS-MD-1650-695-450
1650	925	450	DESS-MD-1650-925-450
1650	1300	450	DESS-MD-1650-1300-450
1650	695	613	DESS-MD-1650-695-613
1650	925	613	DESS-MD-1650-925-613
1650	1300	613	DESS-MD-1650-1300-613

## Desserte montants décentrés hauteur 1250 mm

- 2 Montants en " L " hauteur 850 mm perforés
- 1 Tablette basse avec rebords L 870 x P 613 ou 450 mm
- 4 Roulettes Ø 125 mm pivotantes dont 2 avec freins
- 1 poignée de manutention
- Reçoit en option tablettes et accessoires

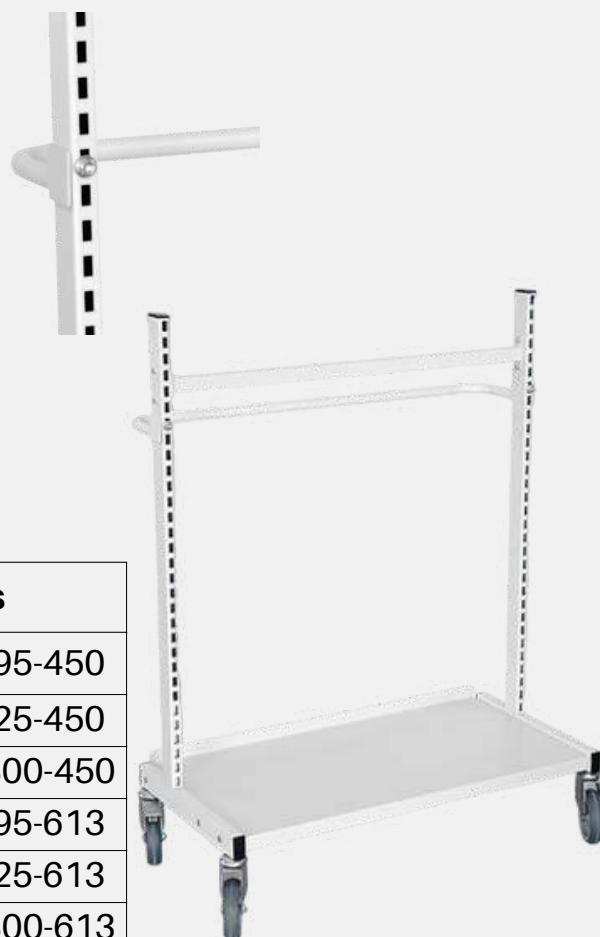

H (mm)	L (mm)	P (mm)	Références
1250	695	450	DESS-MD-1250-695-450
1250	925	450	DESS-MD-1250-925-450
1250	1300	450	DESS-MD-1250-1300-450
1250	695	613	DESS-MD-1250-695-613
1250	925	613	DESS-MD-1250-925-613
1250	1300	613	DESS-MD-1250-1300-613

## Simple Superstructure

L 695 x H 990 mm	DAV-SUP-990-695-2
L 695 x H 1446 mm	DAV-SUP-1446-695-2
L 695 x H 1926 mm	DAV-SUP-1926-695-2

L 925 x H 990 mm	DAV-SUP-990-925-2
L 925 x H 1446 mm	DAV-SUP-1446-925-2
L 925 x H 1926 mm	DAV-SUP-1926-925-2

L 1300 x H 990 mm	DAV-SUP-990-1300-2
L 1300 x H 1446 mm	DAV-SUP-1446-1300-2
L 1300 x H 1926 mm	DAV-SUP-1926-1300-2



## Double Superstructure

L 1365 x H 990 mm	DAV-SUP-990-1365-3
L 1365 x H 1446 mm	DAV-SUP-1446-1365-3
L 1365 x H 1926 mm	DAV-SUP-1926-1365-3

L 1825 x H 990 mm	DAV-SUP-990-1825-3
L 1825 x H 1446 mm	DAV-SUP-1446-1825-3
L 1825 x H 1926 mm	DAV-SUP-1926-1825-3

L 1595 x H 990 mm	DAV-SUP-990-1595-3
L 1595 x H 1446 mm	DAV-SUP-1446-1595-3
L 1595 x H 1926 mm	DAV-SUP-1926-1595-3

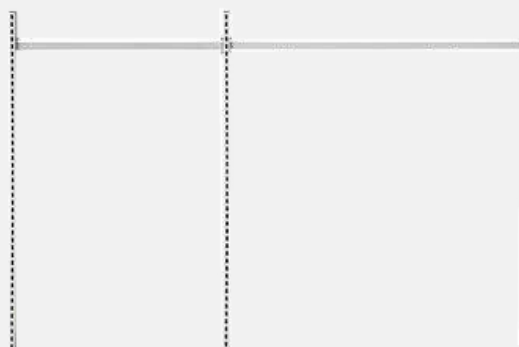

L 1970 x H 990 mm	DAV-SUP-990-1970-3
L 1970 x H 1446 mm	DAV-SUP-1446-1970-3
L 1970 x H 1926 mm	DAV-SUP-1926-1970-3

L 2200 x H 990 mm	DAV-SUP-990-2200-3
L 2200 x H 1446 mm	DAV-SUP-1446-2200-3
L 2200 x H 1926 mm	DAV-SUP-1926-2200-3

## Repose Pieds Ergonomique ESD

- Repose pieds réglable en hauteur par vérin à gaz
- Inclinaison 0° à 30°
- Réglage hauteur de 110 à 320 mm



DAV90ESD

## Roulettes

- Corps de roue en polypropylène
- Bande caoutchouc synthétique gris non tachant
- Charge admissible :
- 75 kg Ø 75 mm - Hauteur total 100 mm
- 80 kg Ø 125 mm - Hauteur total 160 mm



Ø	Non ESD	ESD
75 mm	DAV-75-SF	DAV-75-SF-ESD
75 mm à freins	DAV-75-F	DAV-75-F-ESD
125 mm	DAV-125-SF	DAV-125-SF-ESD
125 mm à freins	DAV-125-F	DAV-125-F-ESD

## Patins de mise à niveau

- Ø 47 mm - hauteur du patin : 11 mm
- Longueur de filetage: 55 mm - Filetage M10
- Hauteur totale: 66mm



DAV-PATIN-47

## Etagère Fonctionnelle

- Etagère en tôle d'acier plié ep: 20/10e
- Jusqu'à deux tablettes
- Hauteur des montants : 750 mm
- Profondeur des montants : 415 mm



### 1 Tablette

L: 1300 mm	L: 1500 mm	L: 1800 mm	L: 2000 mm	L: 2400 mm
DAV-EF-1300	DAV-EF-1500	DAV-EF-1800	DAV-EF-2000	DAV-EF-2400

### Tablette supplémentaire

L: 1300 mm	L: 1500 mm	L: 1800 mm	L: 2000 mm	L: 2400 mm
DAV-EFS-1300	DAV-EFS-1500	DAV-EFS-1800	DAV-EFS-2000	DAV-EFS-2400

# ▲ ACCESSOIRES

## Support poubelle

- Poubelle latérale amovible de 60L
- Se fixe sur le côté du plan de travail
- Charge Admissible : 15 Kg



25.108.0001

## Support rouleau

- Support étiquette, rouleau essui-tout
- Permet d'accueillir un rouleau de maximum 330 mm
- Tube coulissant permettant le positionnement de plusieurs rouleaux
- Changement du consommable sans outils grâce aux poignées étoiles



25.107.001

## Support douchette scanner

- Support scanner universel permettant une prise en main aisée

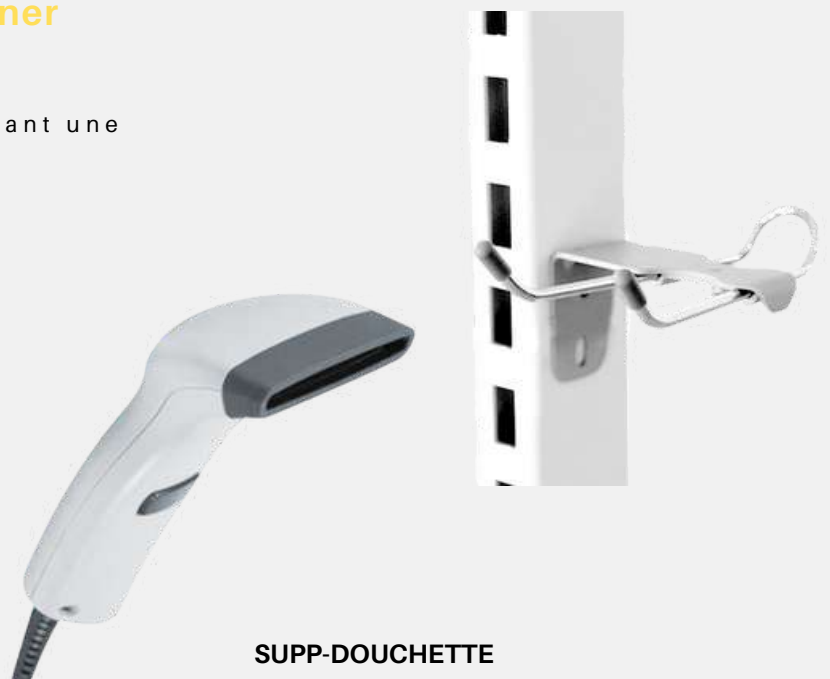

SUPP-DOUCHETTE

# ACCESSOIRES

## Armoire à rideaux

- Armoire à rideau avec panneau perforé adapté pour le stockage d'outils
- Ouverture du rideau 2/3 ou totale équipé d'une serrure à clés
- Disponible en longueur :  
1000/1300/1500/1800/2000 mm



## Passerelle

- Goulotte passe-câble venant se fixer sur profilé ou cadre arrière, face intérieur ou extérieur du poste de travail
- Fixation en montants perforés des superstructure à 2 ou 3 montants

L 640 mm	DAV-PC-640
L 870 mm	DAV-PC-870
L1245 mm	DAV-PC-1245



## Voile de fond

- Fixation au cadre arrière
- Dissimule l'espace sous plan de travail
- Gestion des câbles

L: 1100 mm	L: 1300 mm	L: 1500 mm	L: 1800 mm	L: 2000 mm
DAV-VDF-1100	DAV-VDF-1300	DAV-VDF-1500	DAV-VDF-1800	DAV-VDF-2000



## Cadre arrière

- Réalisé en tôle d'acier plié ep : 20/10e de section 40 x 40 mm
- Permet la fixation de superstructures sur les gammes DAV700/800/900



L: 1100 mm	L: 1300 mm	L: 1500 mm	L: 1800 mm	L: 2000 mm	L: 2400 mm
DAV-CA-1100	DAV-CA-1300	DAV-CA-1500	DAV-CA-1800	DAV-CA-2000	DAV-CA-2400

# ▲ ACCESSOIRES

## Tablettes

- Tablette réglable en hauteur par le biais de la superstructure
- Inclinaison réglable 0° 10° 20° via les consoles de fixation
- Profondeur : 210 mm - réversible
- 4 rebords

L 645 x P 210 mm	DAV-TAB-645-210
L 875 x P 210 mm	DAV-TAB-875-210
L 1250 x P 210 mm	DAV-TAB-1250-210



## Tablettes

- Tablette réglable en hauteur par le biais de la superstructure
- Inclinaison réglable 0° 10° 20° via les consoles de fixation
- Profondeur : 300 / 457 mm - réversible
- 3 rebords

L 645 x P 300 mm	DAV-TAB-645-300
L 875 x P 300 mm	DAV-TAB-875-300
L 1250 x P 300 mm	DAV-TAB-1250-300
L 645 x P 457 mm	DAV-TAB-645-457
L 875 x P 457 mm	DAV-TAB-875-457
L 1250 x P 457 mm	DAV-TAB-1250-457



## Séparateur tablettes

- Séparateur pour tablette profondeur 300 & 457 mm
- Idéal pour le rangement de cartons sur des postes d'emballage

L 300 x H 200 mm	DAV-SEP-200
L 300 x H 400 mm	DAV-SEP-400





# ▲ ACCESSOIRES

## Tablettes

- Tablette réglable en hauteur par le biais de la superstructure
- Inclinaison réglable 0° 10° 20° via les consoles de fixation
- Profondeur : 613 mm
- 4 rebords & réversible

L 645 x P 613 mm	DAV-TAB-645-613
L 875 x P 613 mm	DAV-TAB-875-613
L 1250 x P 613 mm	DAV-TAB-1250-613



## Support de bacs

- Support de bacs à bec à 2 niveaux
- Se fixe sur les superstructures
- Inclinaison 0° 20°

L 645	DAV-PLINTHE-645
L 875	DAV-PLINTHE-875
L 1250	DAV-PLINTHE-1250

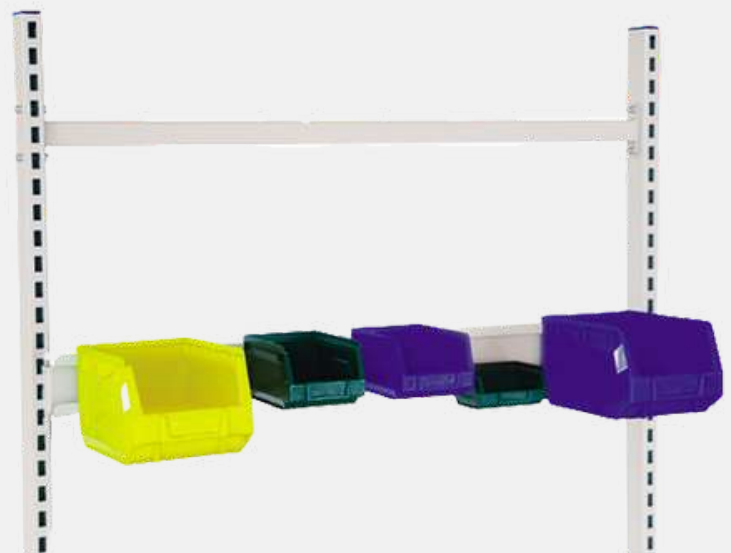

## Panneau plein

- Se fixe sur les superstructures
- Réglable en hauteur
- Magnétique

L 645 x 480 mm	DAV-PANNEAUPL-645
L 875 x 480 mm	DAV-PANNEAUPL-875
L 1250 x 480 mm	DAV-PANNEAUPL-1250

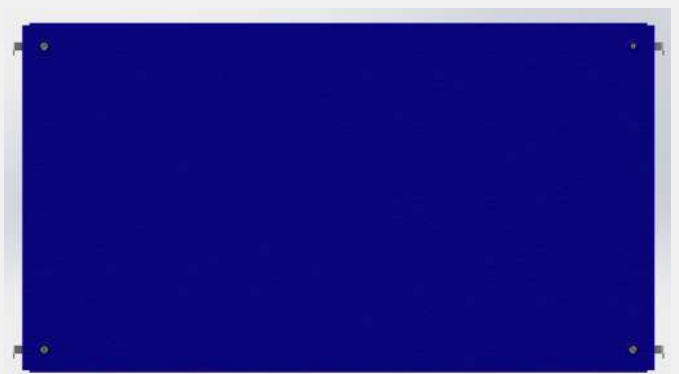

# ▲ ACCESSOIRES

## Panneau perforés

- Se fixe sur les superstructures
- Réglable en hauteur
- Accueille les crochets supports outils
- Magnétique

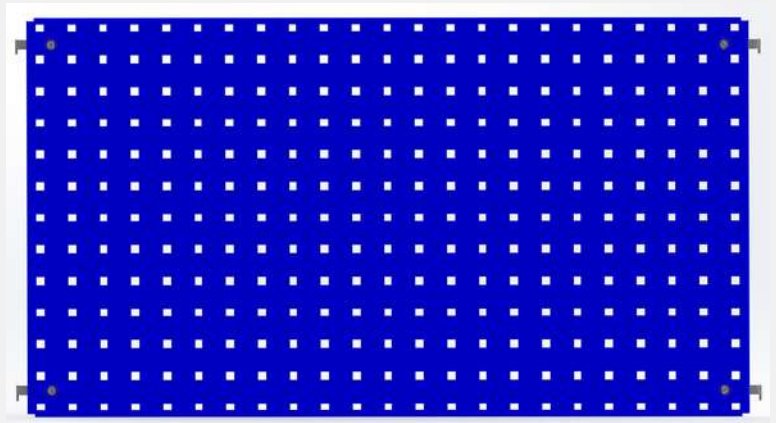

L 645 x 480 mm	DAV-PANNEAUP-645
L 875 x 480 mm	DAV-PANNEAUP-875
L 1250 x 480 mm	DAV-PANNEAUP-1250

## Bras articulé

- Bras à deux articulations
- Se fixe au montants perforés des superstructures
- Réglable en hauteur
- Tube de 50 x 25 x 570 mm



DAV-BRAS

## Bras articulé support de bacs

- Bras à deux articulations
- Se fixe au montants perforés des superstructures
- Réglable en hauteur
- Tube de 50 x 25 x 570 mm
- Reçoit bacs à bec
- L: 545 mm P: 170 mm Ht: 120 mm



DAV-BRAS-SUPP-BAC

## Étagère pivotante sur bras articulé

- Se fixe au montants perforés des superstructures
- Étagère à 4 rebords, pivotante et inclinable 0° 15°
- Réglable en hauteur



L 405 x 305 mm	DAV-ETAG-PIV-405
L 605 x 405 mm	DAV-ETAG-PIV-605

# ▲ ACCESSOIRES

## Panneau perforés sur bras articulé

- Se fixe sur les superstructures
- Réglable en hauteur
- Accueil les crochets supports outils
- Magnétique

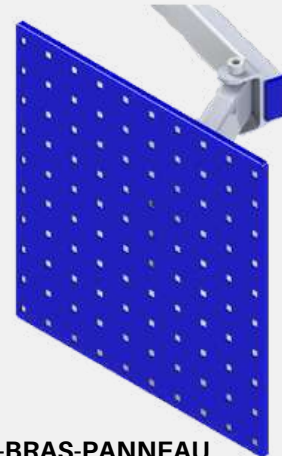

DAV-BRAS-PANNEAU

## Panneau perforé rotatif

- Bras à deux articulations
- Se fixe au montants perforés des superstructures
- Réglable en hauteur
- Reçoit support de bac & panneaux perforés

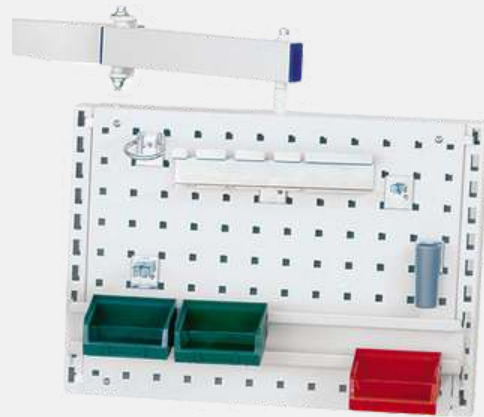

<b>Bras &amp; Cadre L 505 x H 390 mm</b>	<b>DAV-BRAS-ROTATIF</b>
<b>Panneaux Perforés L 450 x H 360 mm</b>	<b>DAV-BRAS-PANNEAU</b>
<b>Support bacs L 480 x H 80 mm</b>	<b>DAV-BRAS-SB</b>

## Bras articulé support écran

- Se fixe au montants perforés des superstructures
- Réglable en hauteur
- Fixation norme VESA (75 x 75 & 100 x 100 mm)



DAV-BRAS-ECRAN

## Bras articulé support écran-clavier-souris

- Se fixe au montants perforés des superstructures
- Réglable en hauteur
- Fixation norme VESA (75 x 75 & 100 x 100 mm)
- Support clavier & souris



DAV-BRAS-EC-CL

# ACCESSOIRES

## Crochets

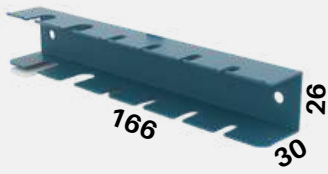

DAV-110-0-01

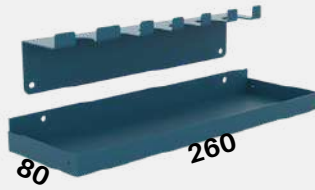

DAV-110-0-02



DAV-110-0-03

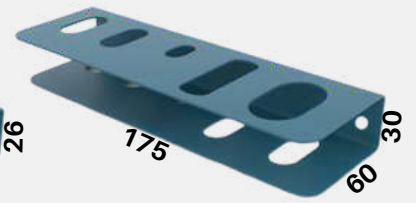

DAV-110-0-04

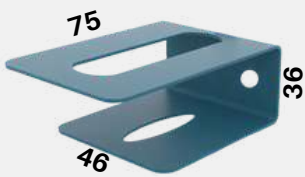

DAV-110-0-05

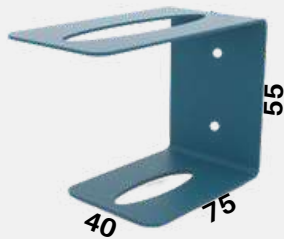

DAV-110-0-06

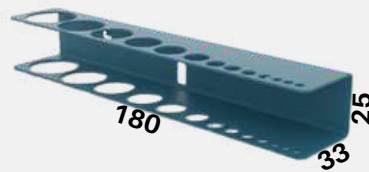

DAV-110-0-07

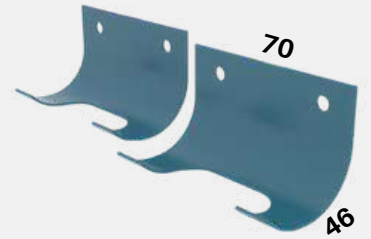

DAV-110-0-08



DAV-110-0-09



DAV-110-0-10



DAV-110-0-11

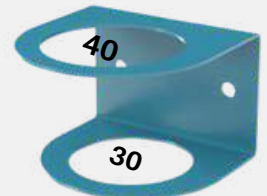

DAV-110-0-12

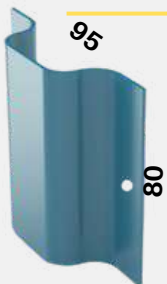

DAV-110-0-13

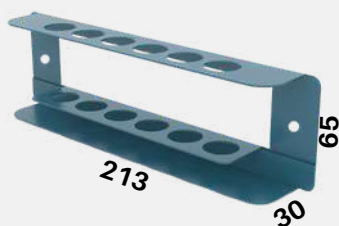

DAV-110-0-14



DAV-110-0-15

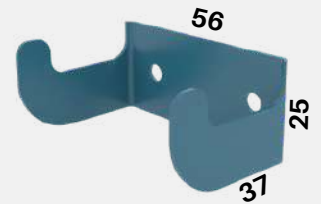

DAV-110-0-16

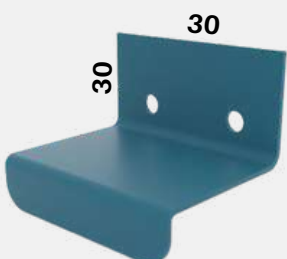

DAV-110-0-17



DAV-110-0-18

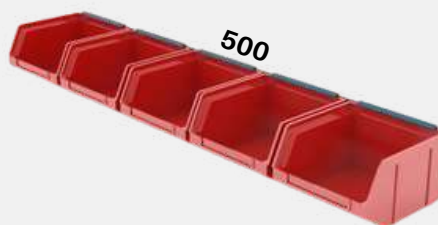

DAV-110-0-19



DAV-110-0-20



DAV-110-0-21

# ACCESSOIRES

## Crochets



DAV-141-0-01

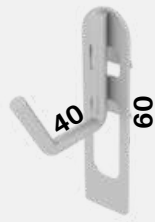

DAV-141-0-02

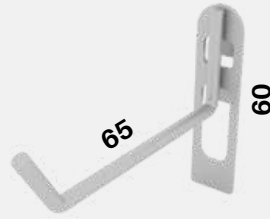

DAV-141-0-03

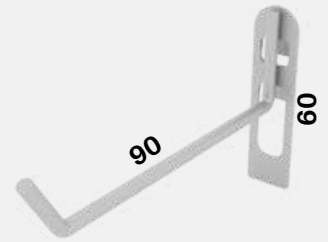

DAV-141-0-04



DAV-141-0-05

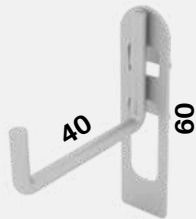

DAV-141-0-06

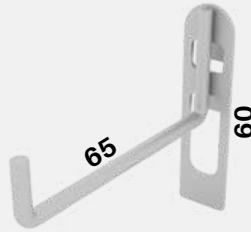

DAV-141-0-07

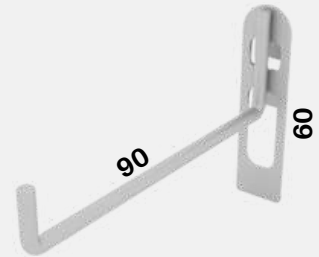

DAV-141-0-08



DAV-141-0-09

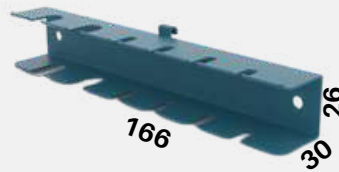

DAV-141-0-12

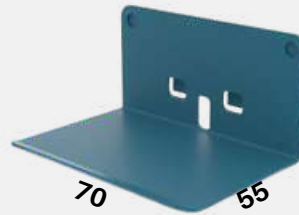

DAV-141-0-13



DAV-141-0-14

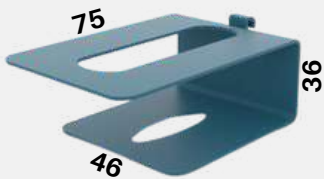

DAV-141-0-15

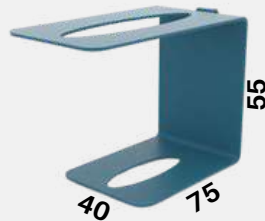

DAV-141-0-16

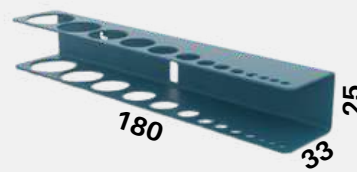

DAV-141-0-17

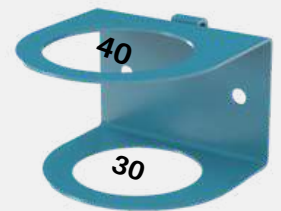

DAV-141-0-21



DAV-141-0-22

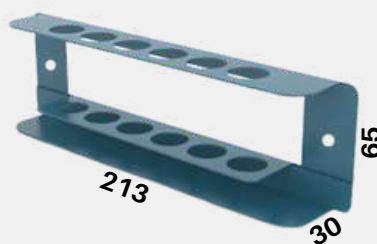

DAV-141-0-23

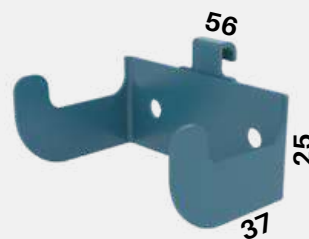

DAV-141-0-24



DAV-141-0-25

# ▲ ACCESSOIRES

## Support mini unité centrale

- Se fixe sur le bras articulé d'un support écran
- Réglable en largeur intérieure de 60 à 100 mm
- Dimension : L: 62 mm H 140 mm P 200 mm

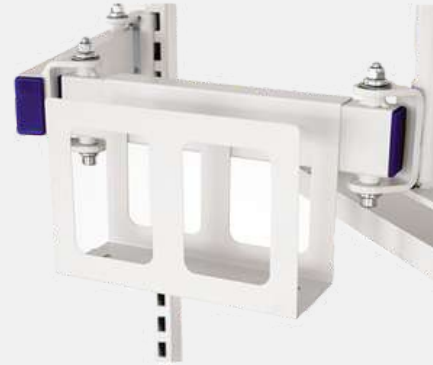

DAV-MINI-UC

## Support écran 3D

- Se fixe sur les montants des superstructures à l'aide d'une mâchoire et platine
- Réglage vertical de 330 mm
- Rotation écran 360°
- Inclinaison 75°
- Charge admissible MAX 11.3 kg
- Ecran jusqu'à 27"
- Passage de câble intégré
- Fixation norme VESA (75x75 & 100x100 mm)



Support écran 3D	DAV-SUP-ECAN-3D
Mâchoire de fixation	DAV-FIX-ECR-3D

## Support écran 3D - Fixation bureau

- Se fixe au bord du plan de travail via un étau de serrage (0-91 mm)
- Réglage vertical de 330 mm
- Rotation écran 360°
- Inclinaison 75°
- Charge admissible MAX 9.1 kg
- Ecran jusqu'à 24"
- Passage de câble intégré
- Fixation norme VESA (75x75 & 100x100 mm)



45-295-026

## Support clavier souris

- Se fixe sous le plan de travail
- Réglable en hauteur et profondeur



DAV-SUP-CLAVIER

# ▲ ACCESSOIRES

## Support écran sur panneau perforés

- Se fixe sur les panneaux perforés
- Rotation 360° - Inclinaison 180°
- Ecran jusqu'à 27"

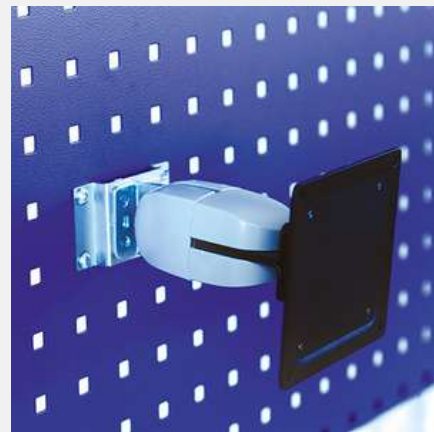

DAV-SUP-ECRAN-PA

## Support unité centrale

- Se fixe sous le plan de travail
- Réglable en hauteur 390 - 540 mm
- Réglable en largeur 130 à 230 mm



DAV-SUP-UC

## Support unité centrale - DAV 100

- Se fixe sur la gamme de poste de travail DAV100
- Peut s'orienter vers l'avant / arrière du poste de travail ainsi que intérieur / extérieur
- Réglable en largeur de 80 à 240 mm



DAV-SUP-UC-100

## Support unité centrale - DAV 200

- Se fixe sous le plan de travail
- Réglable en hauteur et profondeur

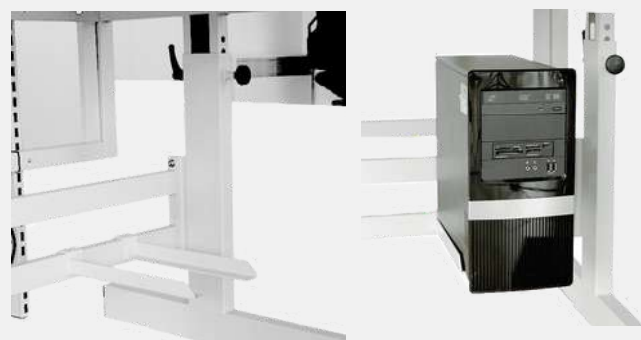

DAV-SUP-UC-200

# ▲ ACCESSOIRES

## Support éclairage & support outils



- Equipé de deux consoles de 700 mm fixé sur les montants perforés des superstructures
- Le rail en "C" de 30x30 permet d'accueil un éclairage ou un chariot de manutention pour suspension d'un outil
- Réglable en profondeur

L: 1100 mm	L: 1300 mm	L: 1500 mm	L: 1800 mm	L: 2000 mm	L: 2400 mm
DAV-SUP-ECL-1100	DAV-SUP-ECL-1300	DAV-SUP-ECL-1500	DAV-SUP-ECL-1800	DAV-SUP-ECL-2000	DAV-SUP-ECL-2400

## Menotte support éclairage

Rail supplémentaire

L: 1100 mm	L: 1300 mm	L: 1500 mm	L: 1800 mm	L: 2000 mm	L: 2400 mm
DAV-C-3030-1100	DAV-C-3030-1300	DAV-C-3030-1500	DAV-C-3030-1800	DAV-C-3030-2000	DAV-C-3030-2400



DAV-MENOTTE

## Chariot suspension outils

- Coulisse dans les profilés en C de 30 x 30 mm permettant le déplacement linéaire d'un outil suspendu



DAV-CHARIOT

## Equilibreur outils

- Se fixe au chariot de suspension pour suspension d'un outil
- Charge admissible: 0.4 à 1 kg



DAV-EQUILIBREUR



# ACCESSOIRES

## Eclairage

- Eclairage LED 27W L: 800 mm et 40W L: 1200 mm
- Diffuseur opale anti éblouissement
- Température de couleur 4000K
- IRC >80
- Intensité lumineuse 3200 et 4500 lumens

L: 800 mm	L: 1200 mm
DAV-ECL-LED800	DAV-ECL-LED1200



## Interrupteur

- Fiche 2P+T 16A 250V Interrupteur On/Off lumineux



DAV-INT

## Eclairage

- Eclairage LED 26W L: 956 mm et 33W L: 1256 mm
- Disponible en version On/Off et version interrupteur variateur déporté sous le plan de travail permettant une gestion ergonomique de l'éclairage
- Diffuseur à prisme conique
- température de couleur : 4000K
- IRC: >80
- Intensité lumineuse : 2150 et 2900 lumens



L: 956 mm On/Off	L: 1256 mm On/Off
112975000-00551349	112979000-00551361

L: 956 mm Commande déportée	L: 1256 mm Commande déportée
112975000-00551349	112979000-00551361

## Eclairage latéral

- Eclairage LED 18W L: 456 mm
- Interrupteur On/Off
- Diffuseur à prisme conique
- Température de couleur 4000K
- IRC >80
- Se fixe sur les montants perforés des superstructures permettant l'orientation de l'éclairage



112989000-00551392

# ACCESSOIRES

## Boitier électrique

- Profilés aluminium de 52 x 60 mm
- Se fixe entre les montants perforés des superstructures à l'aide de pattes de fixation
- Composés de 4,6 ou 8 prises de courant 2P+T -16- 230V
- Equipés au choix d'un interrupteur lumineux ou d'un disjoncteur différentiel 30 mA-16A
- Cordon d'alimentation longueur 3 mètres- 3G 2,5



4 PC + 1 interrupteur lumineux	BOITIER -375-480-INT
4 PC + 1 Disjoncteur différentiel 30 mA	BOITIER - 375-480-DISJ
Support verticale	DAV-SUP-VERTICALE

## RAMPE HORIZONTALE 4 PC



Longueur ( mm )	645	875	1250
4 PC + 1 interrupteur	BOITIER-645-4-INT	BOITIER-875-4-INT	BOITIER-1250-4-INT
4 PC + 1 Disjoncteur différentiel 30 mA	BOITIER-645-4-DISJ	BOITIER-875-4-DISJ	BOITIER-1250-4-DISJ

## RAMPE HORIZONTALE 6 PC



Longueur ( mm )	645	875	1250
6 PC + 1 interrupteur	BOITIER-645-6-INT	BOITIER-875-6-INT	BOITIER-1250-6-INT
6 PC + 1 Disjoncteur	BOITIER-645-6-DISJ	BOITIER-875-6-DISJ	BOITIER-1250-6-DISJ

## RAMPE HORIZONTALE 8 PC



Longueur ( mm )	645	875	1250
8 PC + 1 interrupteur	BOITIER-645-8-INT	BOITIER-875-8-INT	BOITIER-1250-8-INT
8 PC + 1 Disjoncteur	BOITIER-645-8-DISJ	BOITIER-875-8-DISJ	BOITIER-1250-8-DISJ

# ▲ ACCESSOIRES

## RAMPE ÉLECTRIQUE INCLINÉE 4 PC

- Profilé aluminium demi-lune 82 x 77 mm incliné à 45 °
- Se vis sur le plateau
- Combinaison de 4, 6 ou 8 prises de courant 2P+T - 16A 230V
- Muni d'un interrupteur lumineux ou d'un disjoncteur différentiel 30mA - 16A
- Cordon d'alimentation 3 mètres - 3G 2,5



P (mm)	1100	1300	1500
Longueur ( mm )	950	1150	1350
4 PC Interrupteur	BOITIER-INC-950-4-INT	BOITIER-INC-1150-4-INT	BOITIER-INC-1350-4-INT
4 PC Disj 30 mA	BOITIER-INC-950-4-DISJ	BOITIER-INC-1150-4-DISJ	BOITIER-INC-1350-4-DISJ

## RAMPE ÉLECTRIQUE INCLINÉE 6 PC









P (mm)	1100	1300	1500	1800	2000	2400
Longueur ( mm )	950	1150	1350	1700	1800	2250
6 PC Interrupteur	BOITIER-INC-950-6-INT	BOITIER-INC-1150-6-INT	BOITIER-INC-1350-6-INT	BOITIER-INC-1700-6-INT	BOITIER-INC-1800-6-INT	BOITIER-INC-2250-6-INT
6 PC Disj 30 mA	BOITIER-INC-950-6-DISJ	BOITIER-INC-1150-6-DISJ	BOITIER-INC-1350-6-DISJ	BOITIER-INC-1700-6-DISJ	BOITIER-INC-1800-6-DISJ	BOITIER-INC-2250-6-DISJ

## RAMPE ÉLECTRIQUE INCLINÉE 8 PC



P (mm)	1800	2000	2400
Longueur ( mm )	1700	1800	2250
8 PC Interrupteur	BOITIER-INC-1700-8-INT	BOITIER-INC-1800-8-INT	BOITIER-INC-2250-8-INT
8 PC Disj 30 mA	BOITIER-INC-1700-8-DISJ	BOITIER-INC-1800-8-DISJ	BOITIER-INC-2250-8-DISJ

## Néon

Néon 1 Sur patins		Néon 2 Sur roulettes		Néon 3 Sur patins avec marchepieds	
					
Dossier à contact permanent Hauteur d'assise 450 - 620 mm		Système synchrone Hauteur d'assise 450 - 620 mm		Dossier à contact permanent Hauteur d'assise 590 - 870 mm	
		Dossier à contact permanent Hauteur d'assise 450 - 620 mm		Système synchrone Hauteur d'assise 590 - 870 mm	

Tissu Duotec			Cuir synthétique Magic			Mousse polyuréthane			Supertec		
											
9588			9588			9588			9588		
											
Noir	Bleu	Gris	Noir	Bleu	Gris	Noir	Bleu	Gris	Noir	Bleu	Gris



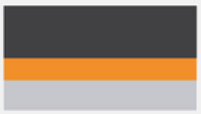
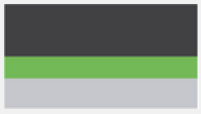
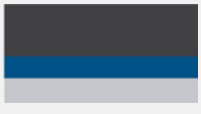
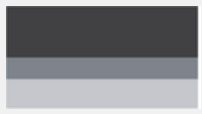





	
Accoudoirs 4D	Roulettes auto-bloquantes pour Néon 3
9589	807



			
3279	3280	3277	3278

## Nexxit

Nexxit 1 Sur patins	Nexxit 2 Sur roulettes	Nexxit 3 Sur patins avec repose-pieds
		
Hauteur d'assise 450 - 600 mm	Hauteur d'assise 450 - 600 mm	Hauteur d'assise 570 - 820 mm

			
3277	3278	3279	3280

Tissu Duotec	Cuir synthétique Magic	Mousse polyuréthane	Supertec
			
			
Noir	Noir	Noir	Noir





 Accoudoirs 4D	 Roulettes auto- bloquantes pour Nexxit 3	 Repose-pieds circulaire pour Nexxit
9039	807	9478

## Isitec

<b>Isitec 1</b> Sur patins	<b>Isitec 2</b> Sur roulettes	<b>Isitec 3</b> Sur patins avec repose-pieds
		
Hauteur d'assise 430 - 600 mm	Hauteur d'assise 430 - 600 mm	Hauteur d'assise 580 - 850 mm

Mousse polyuréthane

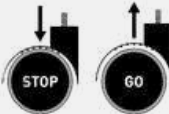
Noir





 Accoudoirs en anneau	 Accoudoirs 4D	 Roulettes auto- blocantes pour Isitec 3	 Repose-pieds circulaire pour Isitec
9390	9353	807	9478

## Unitec

<b>Unitec 1</b> Sur patins	<b>Unitec 2</b> Sur roulettes	<b>Unitec 3</b> Sur patins avec repose-pieds
		
Hauteur d'assise 440 - 620 mm	Hauteur d'assise 440 - 620 mm	Hauteur d'assise 580 - 850 mm

Hêtre	Tissu citadel	Cuir synthétique	Mousse polyuréthane
-------	---------------	------------------	---------------------

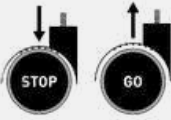
					
Naturel	Noir	Bleu	Noir	Bleu	Noir

 <p>Accoudoirs en anneau (sauf pour version bois)</p>	 <p>Accoudoirs 4D</p>	 <p>Roulettes auto-blocantes pour Unitec 3</p>	 <p>Repose-pieds circulaire pour Unitec</p>
9680	9353	807	9478

## Tabourets

<b>Tabouret 1</b> Sur patins	<b>Tabouret 2</b> Sur roulettes	<b>Tabouret 3</b> Sur patins avec repose-pieds
		
Hauteur d'assise 460 - 630 mm	Hauteur d'assise 460 - 630 mm	Hauteur d'assise 570 - 850 mm

Hêtre	Tissu Duotec	Cuir synthétique Skai	Mousse polyuréthane
-------	--------------	-----------------------	------------------------

									
Naturel	Noir	Bleu	Gris	Rouge	Noir	Bleu	Gris	Rouge	Noir

 <p>Roulettes auto-blocantes pour Tabouret 3</p>	 <p>Repose-pieds circulaire pour Tabouret 3</p>
807	9478



## Néon ESD



Néon 1 ESD Sur patins		Néon 2 ESD Sur roulettes		Néon 3 ESD Sur patins avec marchepieds	
Dossier à contact permanent Hauteur d'assise 450 - 620 mm	Système synchrone Hauteur d'assise 450 - 620 mm	Dossier à contact permanent Hauteur d'assise 450 - 620 mm	Système synchrone Hauteur d'assise 450 - 620 mm	Dossier à contact permanent Hauteur d'assise 590 - 870 mm	Système synchrone Hauteur d'assise 590 - 870 mm

Tissu Duotec ESD			Cuir synthétique Magic ESD		Mousse polyuréthane ESD		Supertec ESD	
9588 E			9588 E		9588 E		9588 E	
Noir	Bleu	Gris	Noir		Noir		Noir	





Accoudoirs 4D ESD	Roulettes auto-blocantes pour Néon 3 ESD
9589 E	807 E





3279	3280	3277	3278

## Nexxit ESD

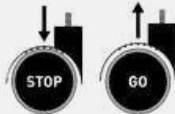

<b>Nexxit 1 ESD</b> Sur patins	<b>Nexxit 2 ESD</b> Sur roulettes	<b>Nexxit 3 ESD</b> Sur patins avec repose-pieds
		
Hauteur d'assise 450 - 600 mm	Hauteur d'assise 450 - 600 mm	Hauteur d'assise 570 - 820 mm

Tissu Duotec ESD	Cuir synthétique Magic ESD	Mousse polyuréthane ESD	Supertec ESD
			
			
Noir	Noir	Noir	Noir



	 Accoudoirs 4D ESD	 Roulettes auto- blocantes pour Nexxit 3 ESD	 Repose-pieds circulaire pour Nexxit 3 ESD
3 2 1 8	9 0 3 9	8 0 7	9 4 7 8





## Unitec ESD



<b>Unitec 1 ESD</b> Sur patins	<b>Unitec 2 ESD</b> Sur roulettes	<b>Unitec 3 ESD</b> Sur patins avec repose-pieds
		
Hauteur d'assise 440 - 620 mm	Hauteur d'assise 440 - 620 mm	Hauteur d'assise 580 - 850 mm

Tissu Duotec ESD	Cuir synthétique Skai ESD
------------------	---------------------------

				
Noir	Bleu	Gris	Rouge	Noir





 Accoudoirs en anneau (sauf pour version bois)	 Accoudoirs 4D ESD	 Roulettes auto-bloquantes pour Unitec 3 ESD	 Repose-pieds circulaire pour Unitec 3 ESD
9680	9353	807	9478

## Tabourets ESD



Tabouret 1 ESD Sur patins	Tabouret 2 ESD Sur roulettes	Tabouret 3 ESD Sur patins avec repose-pieds
		
Hauteur d'assise 460 - 630 mm	Hauteur d'assise 460 - 630 mm	Hauteur d'assise 570 - 850 mm

Tissu Duotec ESD	Cuir synthétique Skai ESD
------------------	------------------------------

				
Noir	Bleu	Gris	Rouge	Noir

 <p>Roulettes auto-blocantes pour Tabouret 3 ESD</p>	 <p>Repose-pieds circulaire pour Tabouret 3 ESD</p>
807	9478

# ▲ NOS RÉALISATIONS SUR-MESURE

---

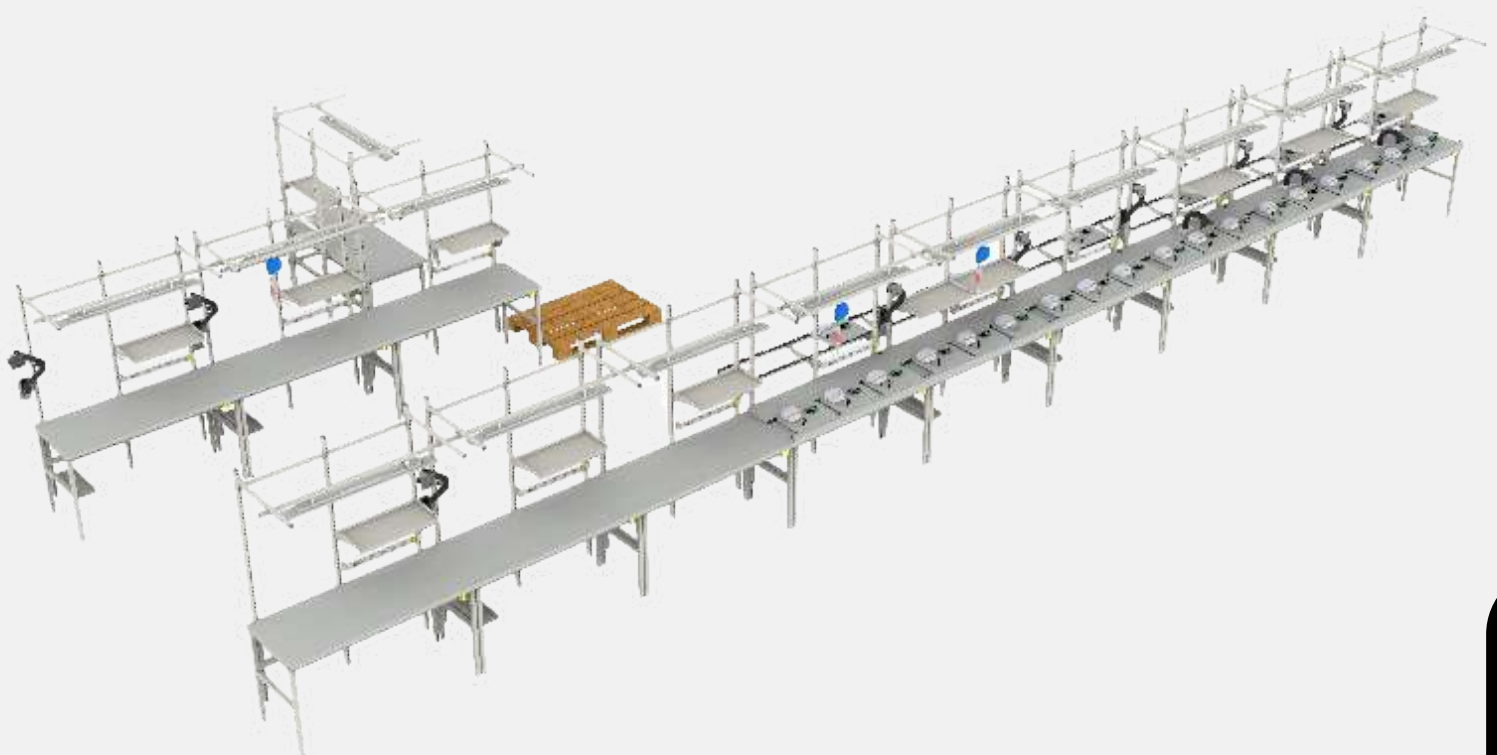
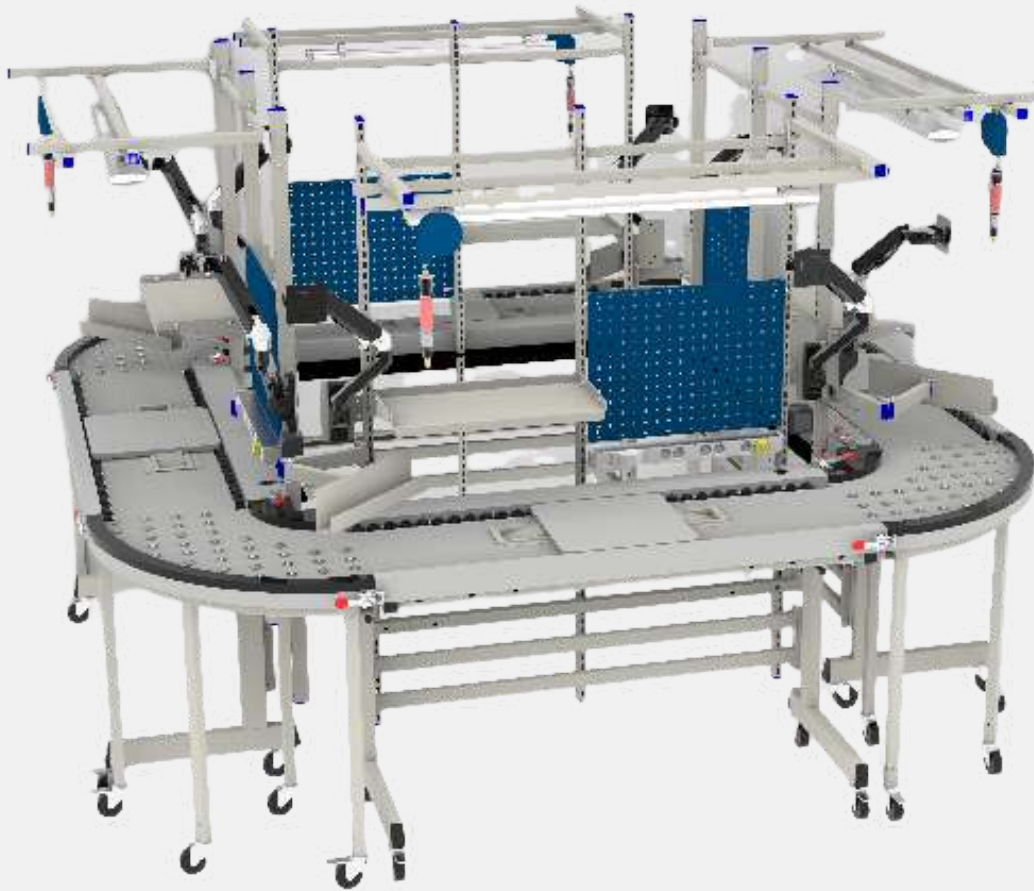

# ▲ NOS RÉALISATIONS SUR-MESURE

---



# ▲ NOS RÉALISATIONS SUR-MESURE



# ▲ NOS RÉALISATIONS SUR-MESURE

---





# ▲ NOS RÉALISATIONS SUR-MESURE



# DAVUM TMC

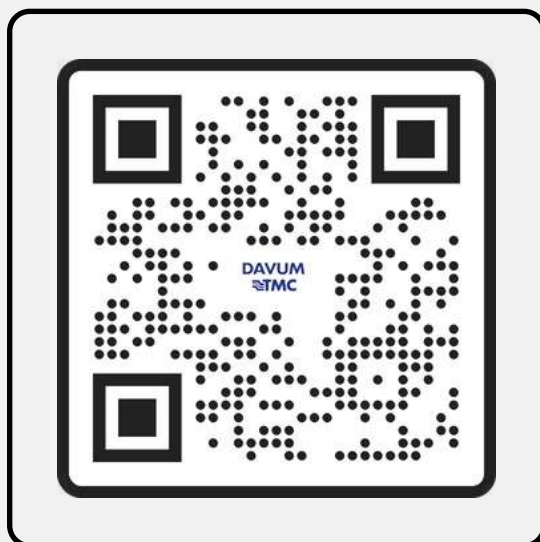

---

30 Rue du Bois Moussay, 93240 Stains  
01 48 36 84 01



Conception  
Fabrication  
Française